



KAPITAŁ LUDZKI
NARODOWA STRATEGIA SPÓJNOŚCI



Politechnika Wroclawska

UNIA EUROPEJSKA
EUROPEJSKI
FUNDUSZ SPOŁECZNY



ROZWÓJ POTENCJAŁU I OFERTY DYDAKTYCZNEJ POLITECHNIKI WROCŁAWSKIEJ

Wrocław University of Technology

Control in Electrical Power Engineering

Bogdan Miedziński, Grzegorz Wiśniewski,
Marcin Habrych

FIBER OPTICS COMMUNICATION AND SENSORS

Wrocław 2011

Projekt współfinansowany ze środków Unii Europejskiej w ramach
Europejskiego Funduszu Społecznego

Wrocław University of Technology

Control in Electrical Power Engineering

Bogdan Miedziński, Grzegorz Wiśniewski,
Marcin Habrych

FIBER OPTICS COMMUNICATION AND SENSORS

Wrocław 2011

Copyright © by Wrocław University of Technology
Wrocław 2011

Reviewer: Eugeniusz Rosołowski

ISBN 978-83-62098-63-7

Published by PRINTPAP Łódź, www.printpap.pl

CONTENTS

MEASUREMENT OF ATTENUATION OF A MULTISEGMENT FIBER OPTICS TRANSMISSION SYSTEM	5
1. Introduction	5
2. Measurement of attenuation	9
2.1. Investigation for different types of the fiber guide	10
2.2. Investigation of the attenuation value for the introduced connector.....	11
2.3. Measurement for different length of the fiber guide.....	13
2.4. Investigation of attenuation for the fixed multisegment system.....	14
2.5. Testing of variation of the fiber attenuation for simple and multisegment transmission path	16
ATTENUATION MEASUREMENT OF OPTICAL FIBER GUIDES	19
1. Introduction	19
2. Investigation of attenuation of the fiber guide	20
2.1. Measuring arrangement and procedure.....	21
2.1.1 Derivation of the light source characteristics.....	22
2.1.2 Frequency characteristic of the light detector	23
2.1.3 Derivation of the fiber guide characteristic.....	25
TESTING OF OPTICAL POLARIZER	28
1. Introduction	28
2. Testing stand and measuring procedure.....	30
2.1. Procedure of testing.....	32
3. Results of investigations - tables:	32
INVESTIGATION OF RADIATION ANGULAR CHARACTERISTICS OF SEMICONDUCTOR LASERS	35

- 1. Introduction 35**
- 2. Investigation of radiation characteristics of semiconductor laser 37**
 - 2.1. Testing procedure 38*

- INVESTIGATION OF OUTPUT SPECTRUM AND LIGHT-CURRENT CHARACTERISTICS OF OPTICAL LIGHT SOURCE 42**
- 1. Introduction 42**
- 2. Testing arrangement 46**
 - 2.1. Testing procedure 47*

- INVESTIGATION OF MATCHING EFFICIENCY OF OPTICAL CONNECTORS 51**
- 1. Introduction 51**
- 2. Investigations of the matching efficiency 53**
 - 2.1. Testing procedure 53*

- References 57**

TASK No. 1

MEASUREMENT OF ATTENUATION OF A MULTISEGMENT FIBER OPTICS TRANSMISSION SYSTEM

Concise specification (manual)

1. Introduction

Due to numerous advantages like: immunity to interference and crosstalk, enormous potential bandwidth, electrical isolation, low transmission loss, high reliability and low cost the optical fiber communication replaces traditional coaxial cables, upgrade the data rate and save space at the same time.

The simple optical transmission path, composed of a transmitter, receiver and fiber guide is presented in Fig. 1.1.

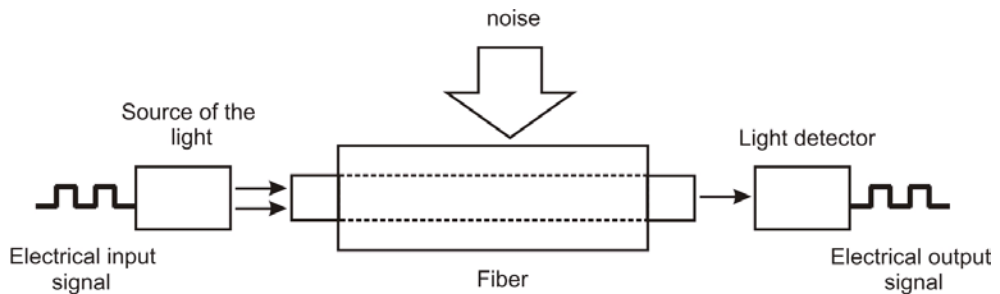

Fig.1.1 Simplified diagram of fiber transmission

However, one has to know that the fiber transmission systems are not ideal and that both dispersion and power losses are unavoidable. The power losses are the most critical when launching the light ray into the fiber and at any other coupling elements being used. Therefore, losses increase with the fiber waveguide length as well as with number of various passive components being employed.

With regard to the number of modes being conducted two basic types of fiber are distinguished: single (SMF) and multimode (MMF) respectively. However, when considering the refractive index distribution there are: step index fiber and graded index fiber.

Single-mode fiber provides much higher transmission bit rate due to decreased attenuation and dispersion values, therefore its bandwidth – length product is over 1GHz km. Its diameter is also smaller (even below 1 μm) therefore, due to decreased NA value (below 0.1) the application of channel couplers is necessary to decrease the coupling losses.

Multi-mode fiber conducts great amount of the modes simultaneously (number of modes can reach even a few thousands) what results in the basic mode distortion due to mutual transfer of energy from higher order modes to the fundamental one. Therefore, it is used for short haul with medium bit rate. The fiber size is much higher compared to the SMF. However, the numerical aperture (NA) is increased what makes the coupling more effective. Comparison of size as well as distribution of the refraction index for different fiber guides are presented for example in Fig. 1.2.

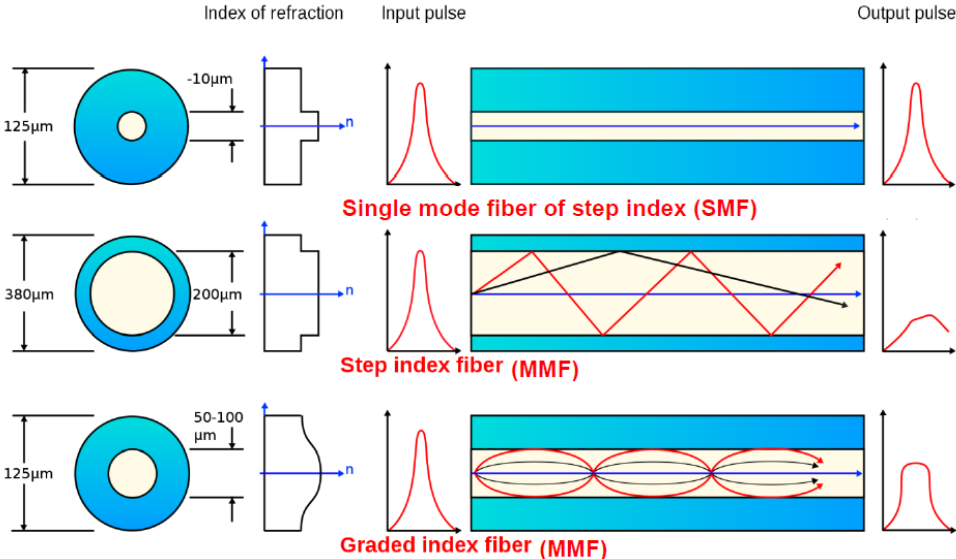

Fig. 1.2 Comparison of optical fiber guide types

Fiber loss as are wavelength-dependent. They are divided into two basic groups: inherent (intrinsic) and induced (introduced) losses. These due to the intrinsic reasons are presented for example in Fig 1.3.

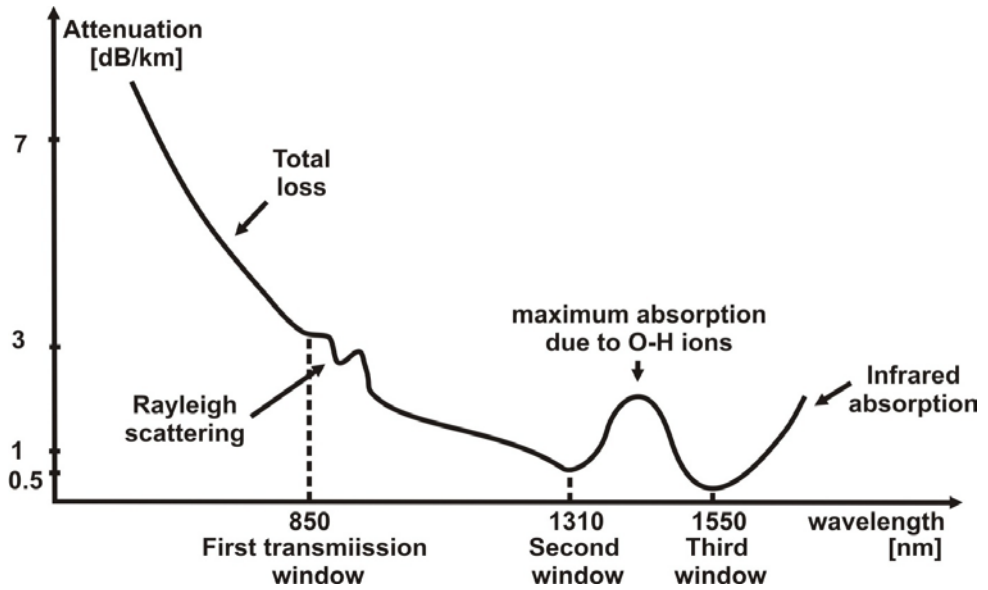

Fig. 1.3 The attenuation spectra for the intrinsic loss for selected fiber guide

Power losses are expressed in decibels as follows:

Number of decibels:

$$dB = 10 \log \frac{P_{out}}{P_{in}} \quad (1.1)$$

Where:

P_{in} - optical power at input,

P_{out} - optical power at output,

P_{out} and P_{in} has to be expressed in the same quantities like [mW], [W], etc.

3dB – corresponds to 50%,

20dB – to 1%,

30dB – to 0.1%,

40dB – to 0.01%, etc.

However, attenuation for the fiber guide is expressed as losses per unit length of fiber:

$$\alpha = \frac{1}{L} 10 \log \frac{P_{out}}{P_{in}} \quad (1.2)$$

where:

L – fiber length.

Note that attenuation expressed in decibels per km is not absolute. The absolute value (expressed in [dBm]) is equal to the logarithm of the ratio of measured output power with respect to input reference, equal to 1 [mW].

$$\alpha [dBm] = 10 \log \frac{P_{out}}{1[mW]} \quad (1.3)$$

where:

10 [mW] corresponds to 10 [dBm];

1.0 [mW] corresponds to 0 [dBm];

0.1 [mW] corresponds to -10 [dBm].

Thus the output power of 100mW converted to dBm is equal:

$$\alpha [dBm] = 10 \log \frac{P_{out}}{1[mW]} = 10 \log \frac{100[mW]}{1[mW]} = 10 \cdot \log(100) = 10 \cdot 2 = 20 [dBm] \quad (1.4)$$

If about the induced fiber losses, the geometrical effect and excessive bending of the fiber guide play important role. The bending losses principle is shown in Fig. 1.4

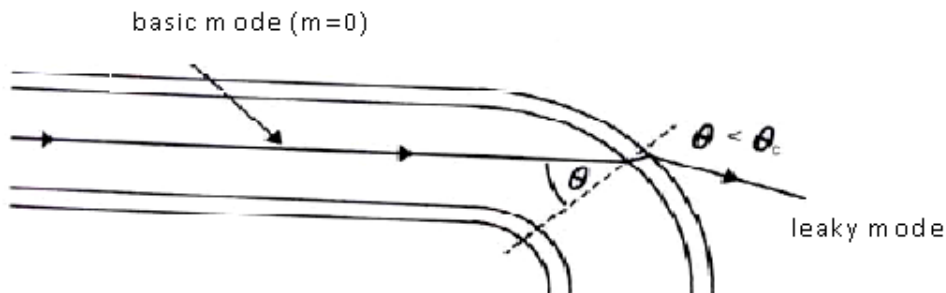

Fig. 1.4 Bending losses (θ_c – critical angle)

2. Measurement of attenuation

All investigations shall be carried out using the same testing arrangement as indicated in Fig 2.1. The test includes following attenuation measurements:

- simple transmission system for two selected different types of the fiber guide,
- system with the fiber guides interconnector,
- transmission system with different lengths of the fiber string,
- multisegment transmission path.

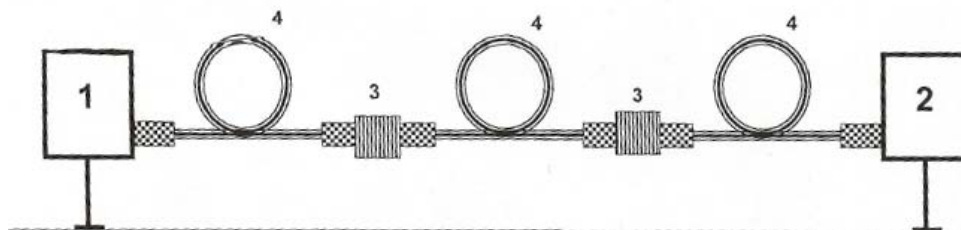

Fig. 2.1. Schematic diagram of the measuring arrangement (1. Light source / source of optical power (FLS-300); 2. Optical power detector (FPM-300) 3. Adapter ST/ST 4. Patchcord ST/ST (standard optical cable)

2.1. Investigation for different types of the fiber guide

The test is to be performed for two selected fiber strings (denoted as blue and orange fiber respectively) using the wave-length equal to 850nm and 1300nm at different level of the input light power. Set-up the circuit as illustrated in Fig 2.2 using the light source (FLS – 300 type) and the power-meter (FPM-300 type) as the transmitter and receiver respectively.

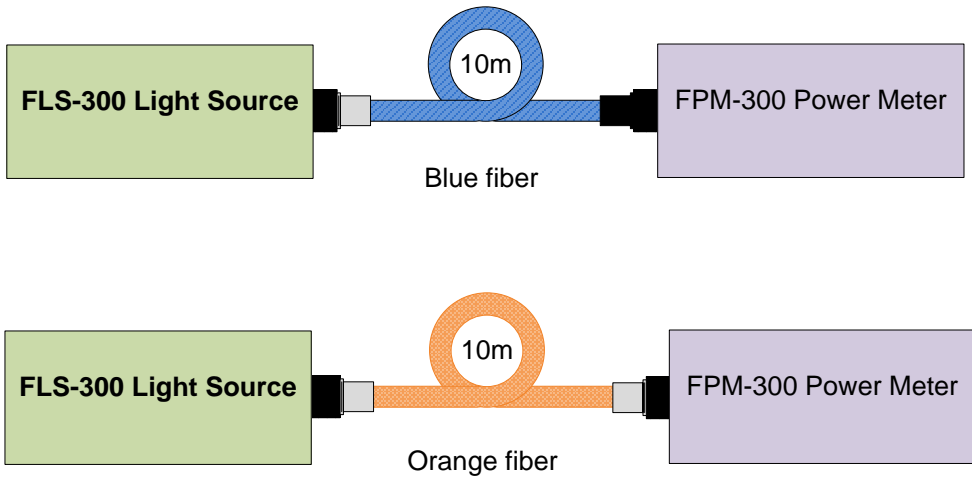

Fig. 2.2 Set-up for testing of the fiber string attenuation

Measure both, the input and output power for different input levels selected both, automatically and manually and calculate the attenuation losses. All investigated results set-up in Table 2.1 and draw respective conclusions.

Table 2.1. Results of measurements of attenuation for different fiber guides (10m)

Lp.	Blue/Orange fiber					
	Wavelengths	Power (input) source	Power value	Power value	Loss in [dB], while reference power value from source in [dBm]	
	λ [nm]	P_{S1} [dBm]	P_{dBm} [dBm]	P_{nW} [nW]	α [dB]	P_{S2} [dBm]
1	850					
2	1300					

2.2. Investigation of the attenuation value for the introduced connectors

Perform testing for the transmission system with introduced connectors (ST/ST) in the circuit as shown in Fig. 2.3. Repeat measurements (5-times) after each connection and following disconnection of the two types of connectors equal to 850nm and 1300nm and list the results in Table 2.2. On the basis of the results formulate the conclusions.

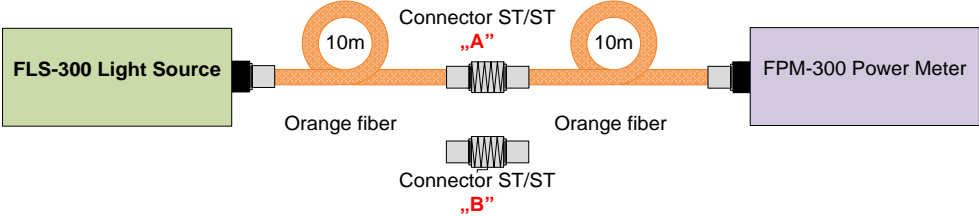

Fig.2.3 Set-up for testing of the influence of the connector

Table 2.2 Testing results of the influence of connector

Connector	Wavelength	Input power	Power value	Loss in [dB], while reference power value from source in [dBm]	
				α [dB]	P_s [dBm]
Lp.	λ [nm]	P_{dBm} [dBm]	P_{nW} [nW]		
1	850				
	1300				
2	850				
	1300				
3	850				
	1300				
4	850				
	1300				
5	850				
	1300				
	1300				
Average value	850				
	1300				

2.3. Measurement for different length of the fiber guide

Set-up the testing circuit as in Fig 2.4. Perform measurements for wavelength adjusted to 850nm and 1300nm while changing the fiber length in the range 3, 5, 10, 15, 50 and 100 meters respectively. The results list into Table 2.3 and plot the power loss – length dependence. Compare the obtained results with the reference data (given in Fig 2.5 for blue fiber).



Orange fiber with lengths of 3, 5, 10, 15, 50 and 100 meters.

Fig 2.4 Set-up for testing the influence of the fiber length

Lp.	Length	Wavelength	Power value	Power value	Loss in [dB], with reference power value from source in -30 [dBm]
	[m]	λ [nm]	P_{dBm} [dBm]	P_{nW} [nW]	α [dB]
1	3	850			
		1300			
2	5	850			
		1300			
3	10	850			
		1300			
4	15	850			
		1300			
5	50	850			
		1300			

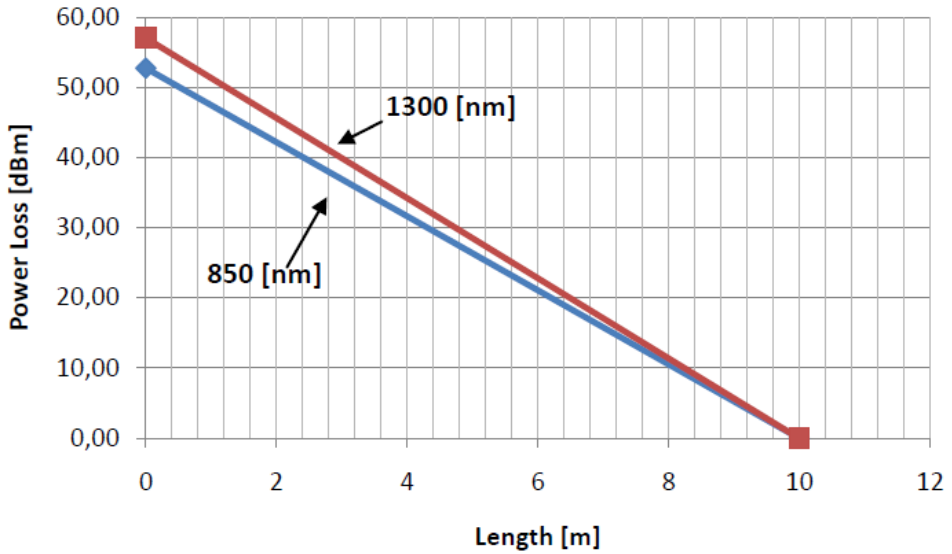

Fig. 2.5 Reference data for the blue fiber guide

2.4. Investigation of attenuation for the fixed multisegment system

Perform investigations in the circuit shown in Fig 2.6, starting from 3m length and increasing gradually by 5m, 10m, 15m, 50m and terminating at the maximum total length equal to 183m. The results list in Table 2.4 and plot relationship $P_{dBm}=f(d)$ and $P_{nW}=f(d)$ and $\alpha=f(d)$. Specify conclusions. Next continue testing for the multicomponent system length equal to 100m and increase it by following (decreased in length) parts equal to 50m, 15m, 10m, 5m and terminating at 3m respectively. Follow with specifying the calculations and conclusions in the way as before.

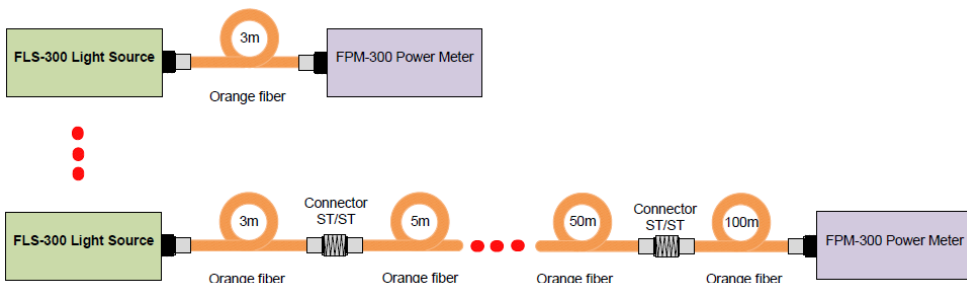

Fig 2.6 Set-up for testing of the multisegment fiber system.

Table 2.4 Testing results of multisegment transmission system

Lp.	Length of multisegment fiber path	Wavelength		Power value	Power value	Loss in [dB], with reference power value from source in -30 [dBm]
		d [m]	λ [nm]	P_{dBm} [dBm]	P_{nW} [nW]	α [dB]
1	3m =	3	850			
			1300			
2	3m + 5m =	8	850			
			1300			
3	3m + 5m +10m =	18	850			
			1300			
4	3m + 5m + 10m +15m =	33	850			
			1300			
5	3m + 5m +10m + 15m + 50m =	83	850			
			1300			
6	3m + 5m +10m + 15m + 50m +100m =	183	850			
			1300			

Lp.	Length of multisegment fiber path	Wavelengths		Power value	Power value	Loss in [dB], with reference power value from source in -30 [dBm]
		d [m]	λ [nm]	P_{dBm} [dBm]	α [dB]	α [dB]
1	100m =	3	850			
			1300			
2	100m + 50m =	150	850			
			1300			
3	100m + 50m +15m =	165	850			
			1300			
4	100m + 50m +15m +10m =	175	850			
			1300			
5	100m + 50m +15m +10m +5m =	180	850			
			1300			
6	100m + 50m +15m +10m +5m +3m =	183	850			
			1300			

2.5. Testing of variation of the fiber attenuation for simple and multisegment transmission path

Perform the test for fixed total length equal to 150m, for simple as well as multisegment system as in Fig. 2.7. Continue for two wavelengths equal to 1300nm and 850nm respectively, inserting the results in Table 2.5. Plot the power loss – length dependence and compare it with the reference data presented in Fig 2.8 and Fig 2.9. Formulate conclusions.

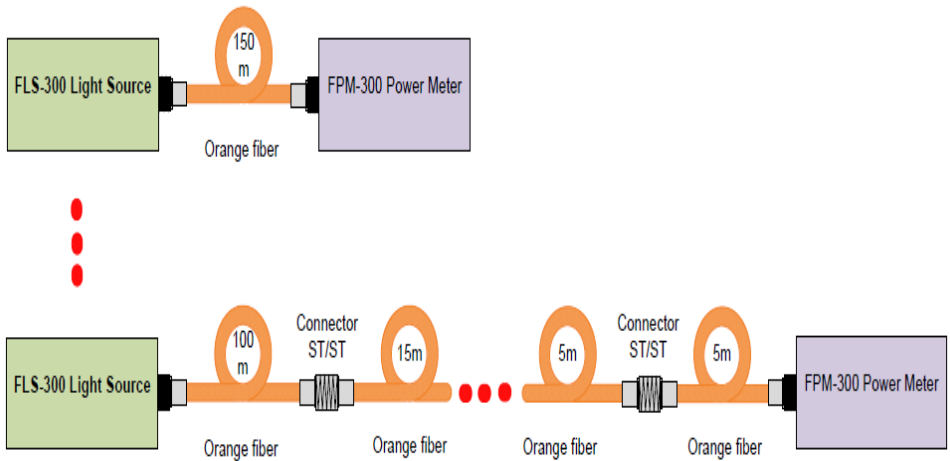

Fig. 2.7 Arrangements for testing attenuation versus system complexity

Table 2.5 Result of comparison of the influence of system complexity.

Lp.	Length of fiber	Wavelength		Power value	Power value	Loss in [dB], with reference power value from source in -30 [dBm]
		d [m]	λ [nm]	P_{dBm} [dBm]	P_{nW} [nW]	α [dB]
1	150m =	150	850			
			1300			
6	100m+15m+15m+10m+5m+5m=	150	850			
			1300			

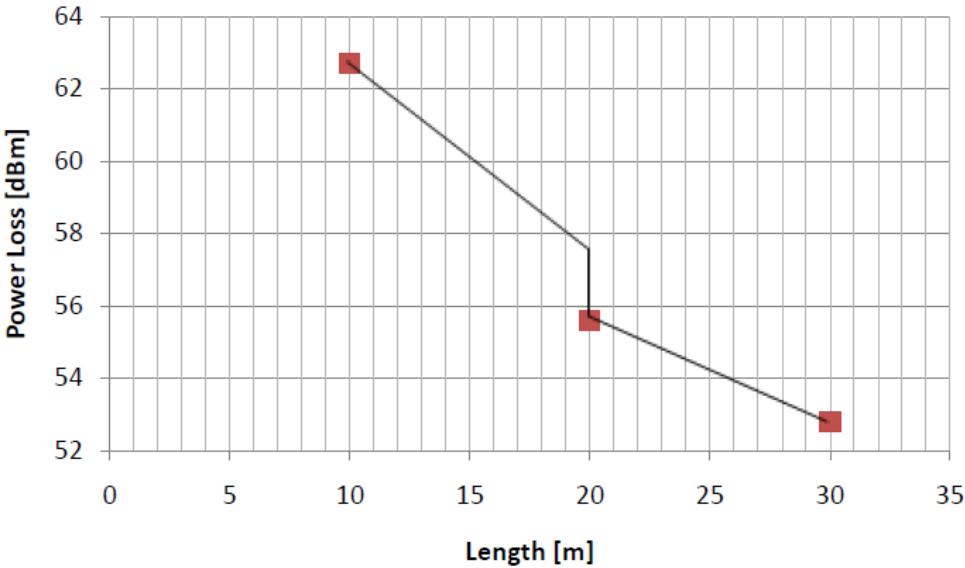

Fig. 2.8. Reference data for the blue fiber at 1300nm

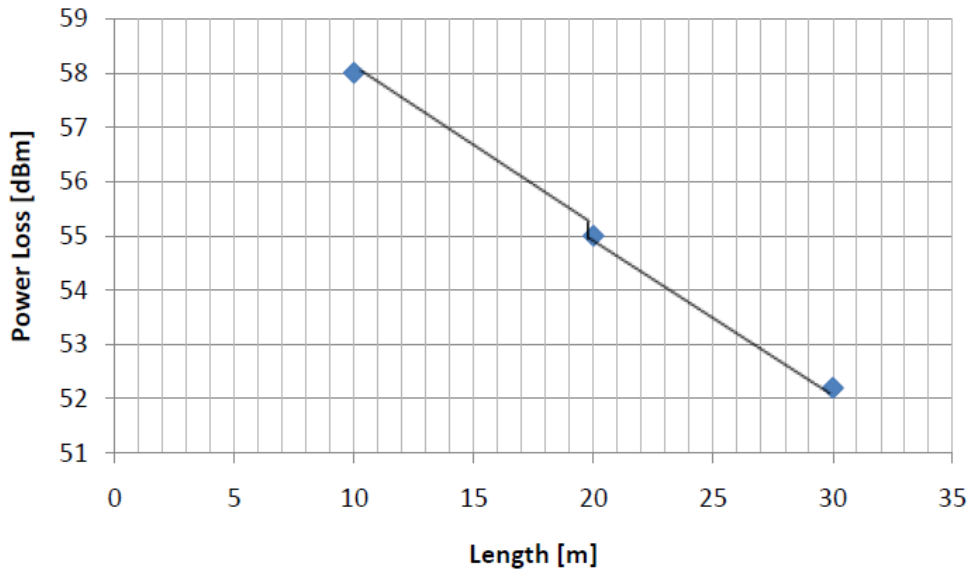

Fig. 2.9. Reference data for the blue fiber at 850nm

TASK No. 2

ATTENUATION MEASUREMENT OF OPTICAL FIBER GUIDES

Concise specification (manual)

1. Introduction

Attenuation in fiber optics, also known as transmission loss, is the reduction in intensity of the light beam (or signal) with respect to distance traveled through a transmission medium. Attenuation coefficients in fiber optics usually have units of dB/km through the medium due to the relatively high quality of transparency of modern optical transmission media. The medium is typically a fiber of silica glass that confines the incident light beam to the inside. Attenuation is an important factor limiting the transmission of a digital signal across large distances. Thus, much research has gone into both limiting the attenuation and maximizing the amplification of the optical signal. Empirical research has shown that attenuation in optical fiber is caused primarily by scattering and absorption.

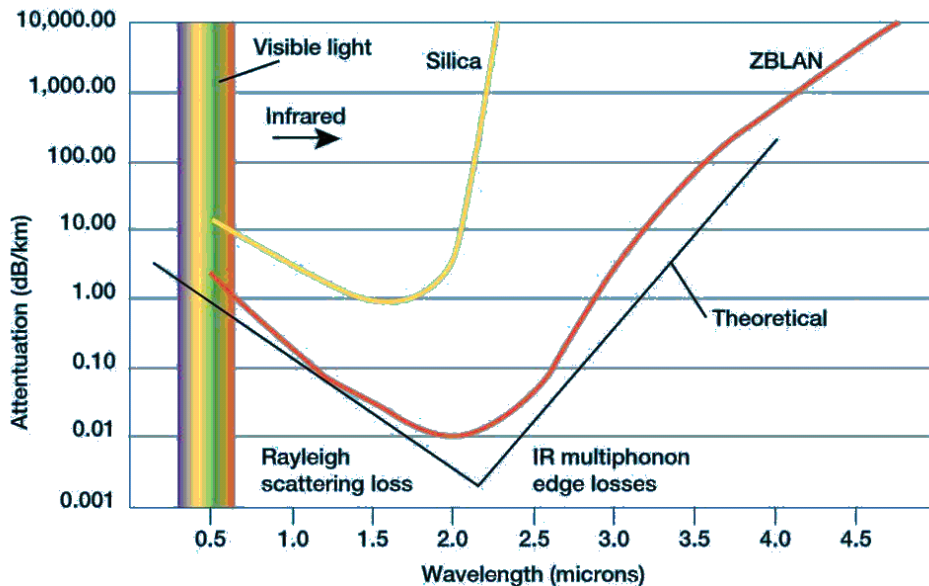

Fig. 1.1 Example of attenuation as a function of wavelength

The propagation of light through the core of an optical fiber is based on total internal reflection of the lightwave. Rough and irregular surfaces, even at the molecular

level, can cause light rays to be reflected in random directions. This is called diffuse reflection or scattering, and it is typically characterized by wide variety of reflection angles.

Light scattering depends on the wavelength of the light being scattered. Thus, limits to spatial scales of visibility arise, depending on the frequency of the incident light-wave and the physical dimension (or spatial scale) of the scattering center, which is typically in the form of some specific micro-structural feature. Since visible light has a wavelength of the order of one micron (one millionth of a meter) scattering centers will have dimensions on a similar spatial scale.

Thus, attenuation results from the incoherent scattering of light at internal surfaces and interfaces. In (poly) crystalline materials such as metals and ceramics, in addition to pores, most of the internal surfaces or interfaces are in the form of grain boundaries that separate tiny regions of crystalline order. It has recently been shown that when the size of the scattering center (or grain boundary) is reduced below the size of the wavelength of the light being scattered, the scattering no longer occurs to any significant extent. This phenomenon has given rise to the production of transparent ceramic materials.

Similarly, the scattering of light in optical quality glass fiber is caused by molecular level irregularities (compositional fluctuations) in the glass structure. Indeed, one emerging school of thought is that a glass is simply the limiting case of a polycrystalline solid. Within this framework, "domains" exhibiting various degrees of short-range order become the building blocks of both metals and alloys, as well as glasses and ceramics. Distributed both between and within these domains are micro-structural defects which will provide the most ideal locations for the occurrence of light scattering. This same phenomenon is seen as one of the limiting factors in the transparency of IR missile domes.

At high optical powers, scattering can also be caused by nonlinear optical processes in the fiber.

2. Investigation of attenuation of the fiber guide

The aim of investigations is to acquaint student with selected in practice measurement methods for attenuation of a simple transmission optical system.

2.1. Measuring arrangement and procedure

Measuring arrangement for attenuation survey of fiber optics consist of following components (see Fig 2.1 and Fig 2.2):

- Lamp
- Lamp power supply adapter ZHA -250
- Optical chopper CH – 40
- Monochromator M250 300nm – 1200nm
- Light detector
- Oscilloscope

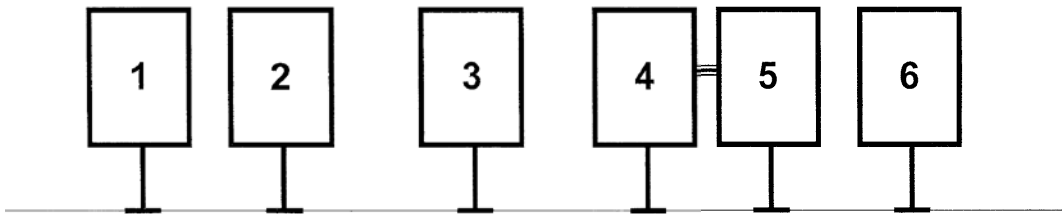

Fig 2.1 Schematic diagram for measurement of characteristics of light source and photodetector

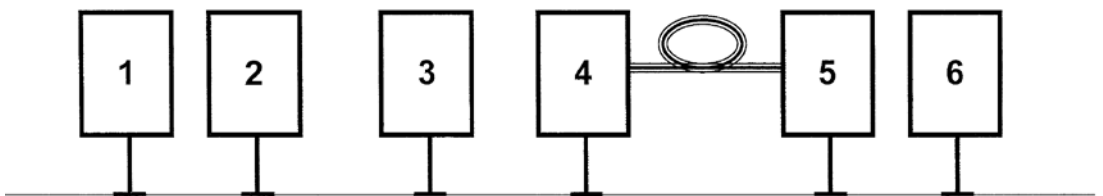

Fig 2.2 System diagram for attenuation survey of fiber optics

where:

- 1) White light source (lamp) with power supply adapter ZHA-250
- 2) Optical chopper CH-40 with frequency control
- 3) Monochromator M250

- 4) Monochromator's output ended with ST type joint
- 5) Light detector
- 6) Oscilloscope

2.1.1 Derivation of the light source characteristics

Set-up the measuring circuit as in Fig 2.1 and put in motion (switch on power supply) the equipment: white light lamp, mechanical chopper and oscilloscope unit. Select the required frequency value at the optical chopper CH-40.

Control the output light power (voltage value at the detector) of white lamp (oscilloscope connected with voltmeter measures peak to peak value) for various lamp driving current (Fig. 2.1.). Next, find the best (optimum) frequency with relation to power light value.

Table 2.1 Voltage-current characteristic of the light source

Lp.	I[A]	U[mV]
1		
2		

Table 2.2 Frequency characteristic of the light source

Lp.	f[Hz]	U[mV]
1		
2		

Compare with the reference data shown in Fig 2.3.

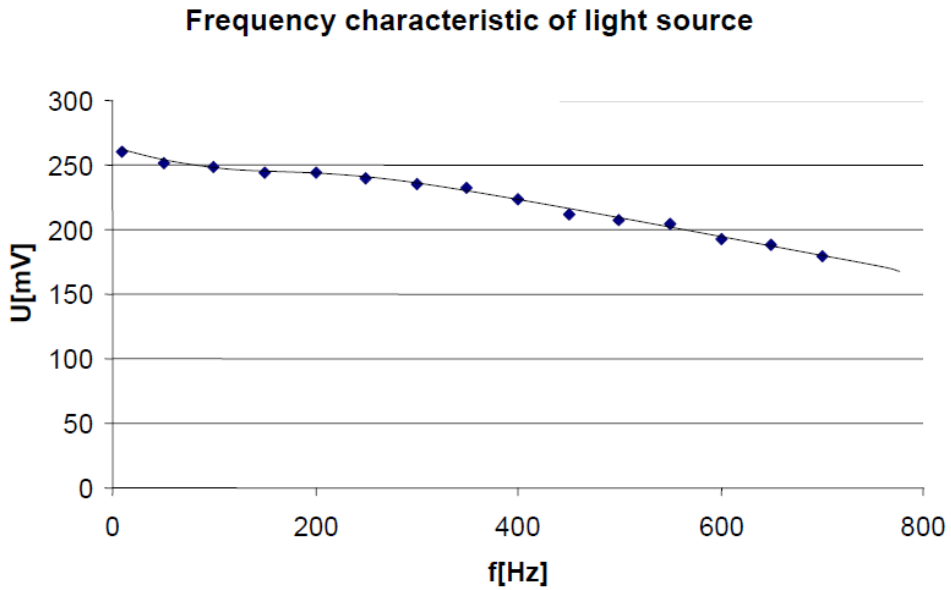

Fig. 2.3. Reference frequency characteristic of light source

2.1.2 Frequency characteristic of the light detector

Perform test using the same circuit as in Fig 2.1. Set – up value of the lamp current and the optical chopper frequency found in chapter 2.1.1. When changing the wavelength value of the chopper derive the detector characteristic (wavelength as a function of the detector voltage). Example of measurement results are shown in Table 2.3.

Table 2.3. Fiber guide and detector characteristics

Lp.	Indication of counter	λ [nm]	U[mV]	U[p.u.]
1	148.7	446.10	20	0.079
2	200.1	630.00	200	0.794
3	250.4	788.76	252	1
4				
5				

One should find the multiplication factor of scale of the monochromatic unit to select real value of the wave light length. Thus, one has to set the monochromatic unit output to obtain the red light and refer it to 630nm

Example of calculation is shown below:

$$x = \frac{\text{length of red light}}{\text{counter}} = \frac{630}{200,1} \approx 3.15 \quad (2.1)$$

$$\lambda = x \cdot (\text{Indication of counter})$$

$$\lambda = 3.15 \cdot 148.7 = 468.4[\text{nm}]$$

Refer the measured value of voltage to value per unit (U_{MAX} -max voltage value of detector)

$$U_{MAX} = 252\text{mV}$$

$$U_i = 20\text{mV}$$

$$U[\text{p.u.}] = \frac{U_i[\text{mV}]}{U_{MAX}[\text{mV}]} = \frac{20[\text{mV}]}{252[\text{mV}]} = 0,0794[\text{p.u}] \quad (2.2)$$

Thus, attenuation α of signal is equal to:

$$\alpha = U_F(\lambda) + 1 - U_D(\lambda) \quad (2.3)$$

where:

($U_{D[p.u.]}$ - voltage p.u. value of detector, $U_{F[p.u.]}$ - voltage p.u. value of fiber)

Check with the reference characteristic presented in Fig 2.4.

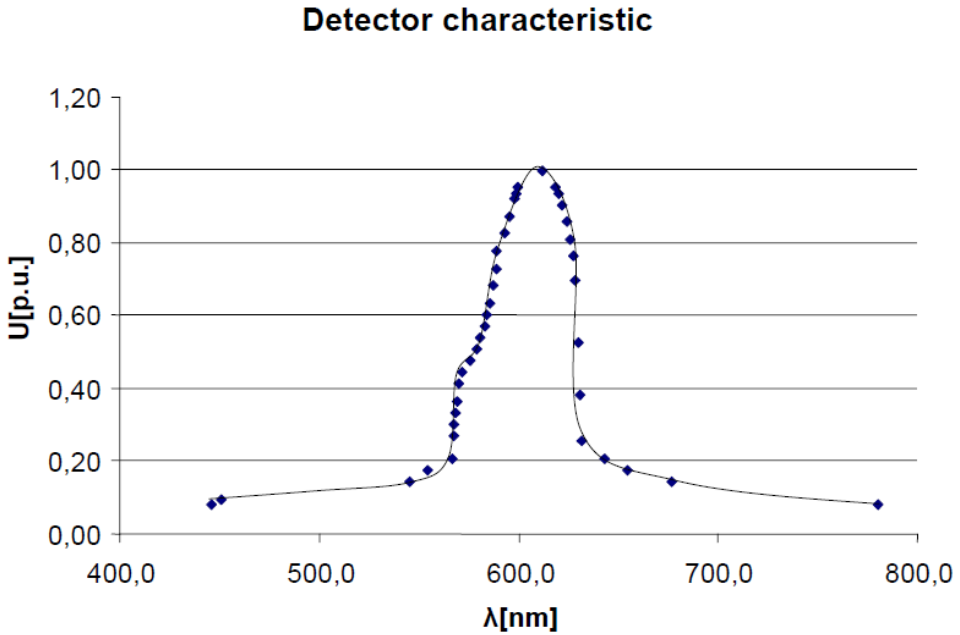

Fig. 2.4. Detector characteristic

2.1.3 Derivation of the fiber guide characteristic

Set-up the measuring circuit as in Fig. 2.2. Adjust values for both lamp current and the optical chopper frequency as in chapter 2.1.2. Derive the fiber guide characteristic (wavelength as function of voltage) when changing the monochromator wave length. Before drawing the characteristic one has to assume the detector characteristic to be linear. The measurements should be perform for two kinds (blue and orange) of fiber.

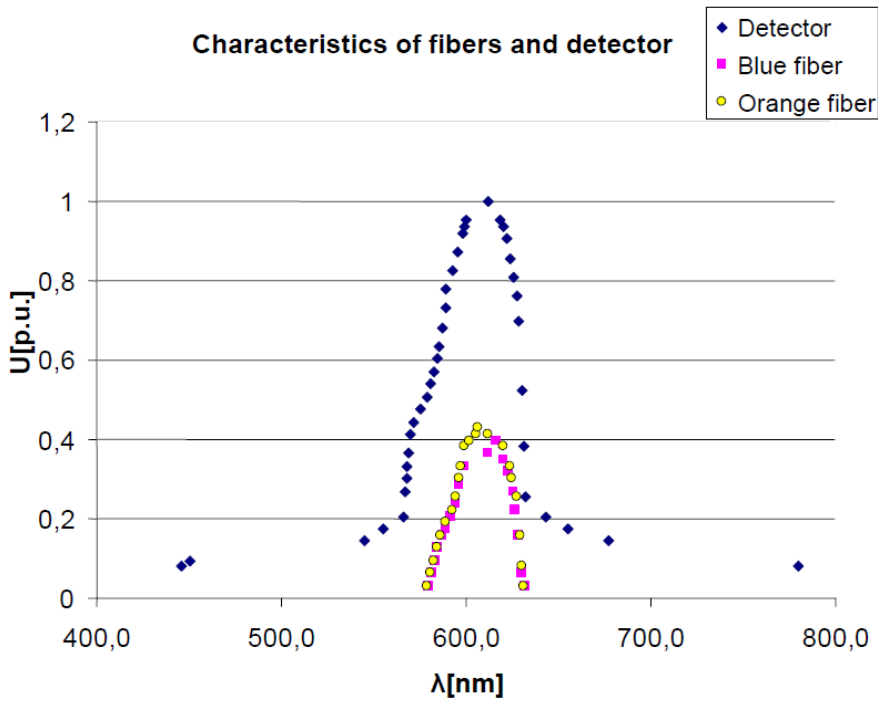

Fig. 2.5. Fibers and detector characteristics

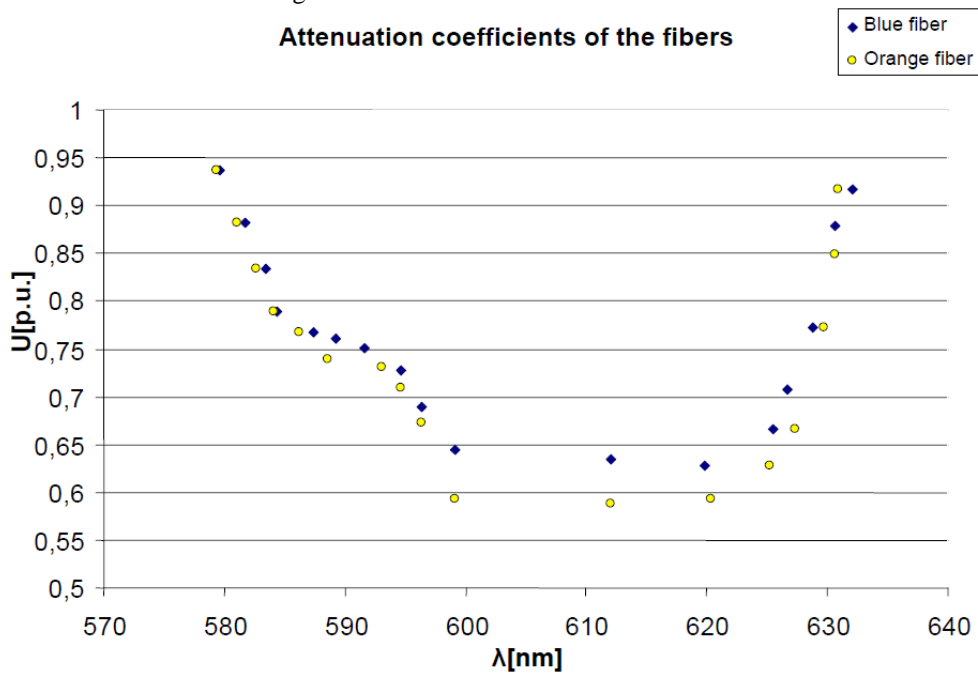

Fig. 2.6. Attenuation of the signal in both fibers.

Compare the derived characteristics with those of reference indicated in Fig 2.5 and Fig 2.6. Formulate conclusions and find out the optimum transmission window.

TASK No. 3
TESTING OF OPTICAL POLARIZER
Concise specification (manual)

1. Introduction

Light indicates properties typical for as a particle and an electromagnetic wave. Its electromagnetic wave properties allow it to become polarized.

The light emanating from some sources like sun, light bulb etc. vibrates in all directions at different angles to the direction of propagation and in general is unpolarized. In many cases there is a need to produce light which vibrates in a single direction and a need to know the vibration direction of the light ray. These two requirements can be easily met when forcing the polarization of the light produced by the light source, by means of a polarizing filter. One has to know that the electric field intensity indicates polarization of the light ray.

Three types of polarization are possible.

- Plane Polarization
- Circular Polarization
- Elliptical Polarization

The light beam propagating in a given direction can be described as set of plane electromagnetic waves propagating along the same transmission path (Fig. 1.1).

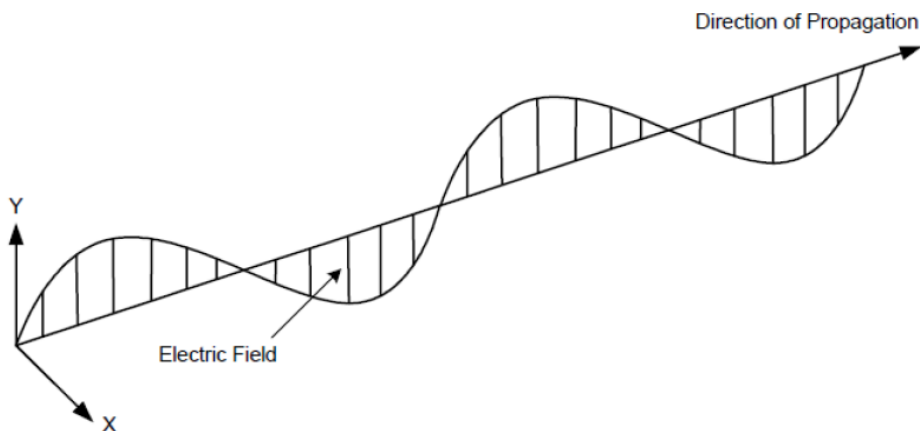

Fig. 1.1. Plane – polarized lightwave

The wave is said to be **linearly polarized** if a single electric field vector perpendicular to the direction of propagation, can represent the wave.

If light is composed of two plane waves of equal amplitude by differing in phase by 90° , then the light is said to be **circularly polarized**. If two plane waves of differing amplitude are related in phase by 90° , or if the relative phase is other than 90° then the light is said to be **elliptically polarized**.

Polarizer can be described by two parameters. First one, k_1 sets transmission of the plate polarizer, which was lit by linear polarized beam oriented to obtain maximum power output. Parameter k_2 sets transmission in this configuration of polarizer plate and the incident beam, to obtain a minimal power output. In the ideal situation these values are equal $k_1=1$, $k_2=0$. In the case of real objects these parameters are equal to the ratio of intensity of the outgoing beam (I_{out}) to intensity of the beam incident (I_{in}) respectively:

$$k_i = \frac{I_{out}}{I_{in}} \quad (1.1)$$

The value of the intensity of the outgoing beam for real polarizers can take it from the interval $\langle k_1, k_2 \rangle$ and is dependent on the angle between the plane of the polarizer, and the plane of polarized beam.

Polarizers can be divided into two general categories: **absorptive polarizers**, where the unwanted polarization states are absorbed by the device, and **beam-splitting polarizers**, where the unpolarized beam is split into two beams with opposite polarization states.

The simplest polarizer in concept is the wire-grid one, which consists of a regular array of fine parallel metallic wires, placed in a plane perpendicular to the incident beam. Electromagnetic waves which have a component of their electric fields aligned parallel to the wires induces the movement of electrons along the length of the wires. Since the electrons are free to move, the polarizer behaves in a similar manner as the surface of a metal when reflecting light; some energy is lost due to Joule heating in the wires, and the rest of the wave is reflected backwards along the incident beam.

For waves with electric fields perpendicular to the wires, the electrons cannot move very far across the width of each wire; therefore, little energy is lost or reflected, and the incident wave is able to travel through the grid. Since electric field components parallel to the wires are absorbed or reflected, the transmitted wave has an electric field purely in the direction perpendicular to the wires, and is thus linearly polarized.

Another way is the polarization by use of a polaroid filter. In its original form it was an arrangement of many microscopic herapathite crystals. Its later H-sheet form is rather similar to the wire-grid polarizer. It is made in from of polyvinyl alcohol (PVA) plastic with an iodine doping. Stretching of the sheet during manufacture ensures that the PVA chains are aligned in one particular direction. Electrons from the iodine dopant are able to travel along the chains, ensuring that light polarized parallel to the chains is absorbed by the sheet; light polarized perpendicularly to the chains is transmitted. The durability and applicability of a polaroid make it the most common type of polarizer in use, for example for sunglasses, photographic filters, and liquid crystal displays. It is also much cheaper than other types of polarizers.

2. Testing stand and measuring procedure

The optical polarizer under test is controlled by an specially designed microcontroller. The laboratory stand consists of a positioning handle of the polarizer, a handle to fix the polarizer together with driving system, a light source (laser), detectors and the microcontroller (programmer) as well. (see Fig. 2.1)

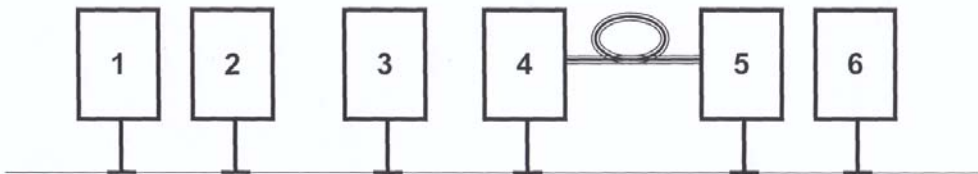

Fig. 2.1. Simplified diagram of the measuring system.

where:

1. Source of the monochromatic light – (LASER).
2. Polarization lens.
3. Polarization lens.
4. Detector.
5. Detector with fiber (optional).
6. Voltmeter.

During operation it is possible to display three types of indices. The first parameter to be displayed is “Stopnie” (degrees). The others are “Kat” (angle) and “Nap” (voltage) respectively. The change of value of “Stopnie” (degrees) is performed by use of the press-buttons (keys) (2↓) and (8↑).

„Stopnie” (degrees)	–	displays the angle value by which the polarizer was turned
„Kat” (angle)	–	indicates the angle difference between current position of the polarizator and that at the beginning of measurements
„Nap” (voltage)	–	displays current voltage value begin set-up at the detector (in mV)

After required setting is completed one has to press the key (CLEAR↵) to turn over the polarizer. The microcontroller, according to setup will update both values of “Kat” (angle) and “Nap” (voltage) respectively. Depending on requirements for the sign (positive or negative) of the angle the polarizer will turn to the right or to the left. The press-button “Shift” accomplishes reset-function of the microcontroller. As a result values of both “Stopnie” (degrees) and “Kat” (angle) will be cleared.

Example of testing procedure:

- 1) After switching on the controller-press the key (4←)
- 2) Set-up required step value of the measurements – key (2↓) or (8↑)
- 3) Read off the voltage value displayed by the detector
- 4) Pass to the next measuring point – key (CLEAR↵)
- 5) Read off the voltage value of the new measuring step
- 6) The following measures are exactly the same as in points 4 and 5 until full turn of the polarizer is made

If any measuring point is passed over it is possible to go back by respective value adjustment of “Stopnie” (degrees) however, at negative sign-minus – press the button (2↓)

or (8↑). After having recorded the omitted measuring point, reset the measuring step by means of the press-buttons (2↓) or (8↑)

2.1. Procedure of testing

- Supply equipment: red light laser and optical detector without polarizations.
- Adjust equipment to get maximum and minimum output signal of the optical detector.
- Fix one of two polarizator lenses onto the base and measure the characteristic angle using voltmeter (min. resolution 2 degrees).
- Replace polarization lens with the other and repeat measurement (min. resolution 2 degrees).
- Choose one from two polarization lenses to set optional angle value and repeat measurement of angle characteristic for the second lens (min. resolution 2 degrees).
- Consider the obtained measured results and formulate conclusions.

3. Results of investigations - tables:

Table 3.1. Reference values.

No.	Parameter	measured value
		[mV]
1	Lower reference value	
2	Upper reference value	

Table 3.2. Light intensity after passing through the first, second, and both polarizers respectively as a function of angle θ

No.	Angle θ	1st Polarizer		2nd Polarizer		Both Polarizers	
	[°]	Measured value [mV]	Per unit	Measured value [mV]	Per unit	Measured value [mV]	Per unit
1	0						
2	2						
3	4						
4	6						
5	8						
6	10						
7	12						

Example of calculation:

$$X_i = \frac{X_p - W_D}{W_G - W_D} \quad (3.1)$$

X_i - Value of standardized measurement [p.u.].

X_p - Measured value [mV];

W_D - Lower reference value [mV];

W_G - Upper reference value [mV];

Example of chart:

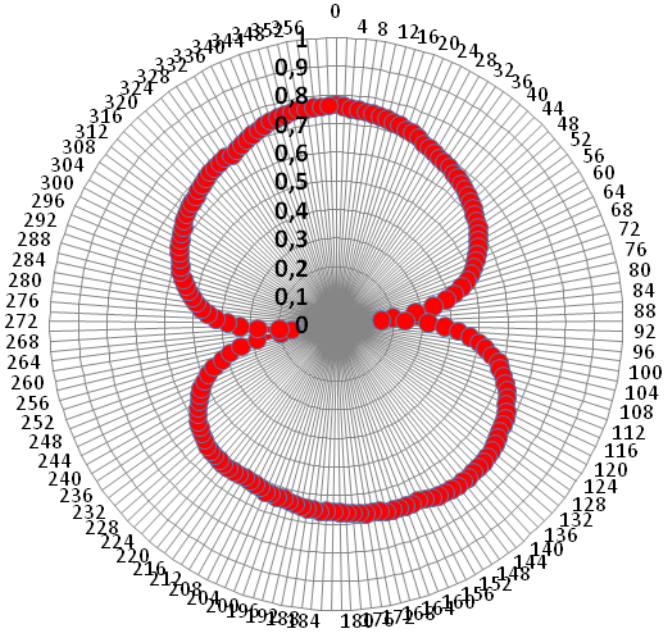

Fig. 3.1. Chart of the light intensity after passing through both polarizers

TASK No. 4

INVESTIGATION OF RADIATION ANGULAR CHARACTERISTICS OF SEMICONDUCTOR LASERS

Concise specification (manual)

1. Introduction

Laser (Light Amplification by Stimulated Emission of Radiation) is a device which produces electromagnetic radiation, often visible light, using the process of optical amplification based on the stimulated emission of photons within a so-called gain medium. The emitted laser light is notable for its high degree of spatial and temporal coherence, unattainable using other technologies. Temporal (or longitudinal) coherence implies a polarized wave at a single frequency whose phase is correlated over a relatively large distance (the coherence length) along the beam. This is in contrast to thermal or incoherent light emitted by ordinary sources of light whose instantaneous amplitude and phase varies randomly with respect to time and position. Although temporal coherence implies monochromatic emission, there are lasers that emit a broad spectrum of light, or emit different wavelengths of light simultaneously.

Most so-called "single wavelength" lasers actually produce radiation in several modes having slightly different frequencies (wavelengths), often not in a single polarization. There are some lasers which are not single spatial mode and consequently their light beams diverge more than required by the diffraction limit. However, all such devices are classified as "lasers" based on their method of producing light and are generally employed in applications where light of similar characteristics could not be produced using simpler technologies.

Solid-state laser materials are commonly made by "doping" a crystalline solid host with ions that provide the required energy states. For example, the first working laser was a ruby laser, made from ruby (chromium-doped corundum). The population inversion is actually maintained in the "dopant", such as chromium or neodymium. Formally, the class of solid-state lasers includes also fiber laser, as the active medium (fiber) is in the solid state. Practically, in the scientific literature, solid-state laser usually means a laser with bulk active medium, while wave-guide lasers are called fiber lasers.

"Semiconductor lasers" are also solid-state lasers, but in the customary laser terminology, "solid-state laser" excludes semiconductor lasers, which have their own name. One of the typical green laser pointer is shown in Fig .1.1 as an example.

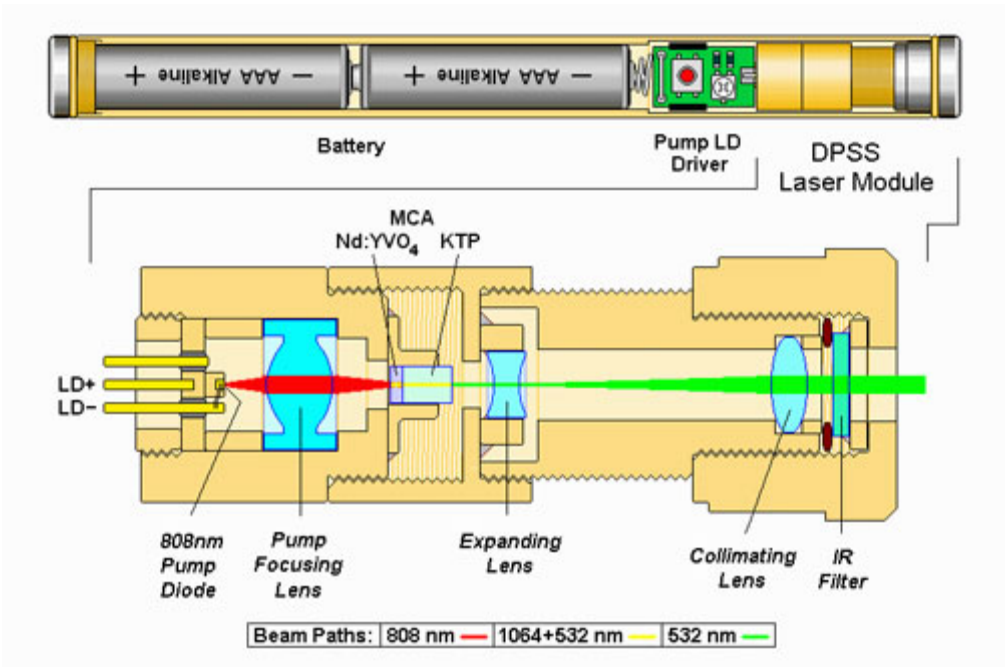

Fig. 1.1 Cross section of the typical Green Laser „pointer”

It is the frequency-doubled green light laser source. The IR diode of 808nm pumps energy to Nd:YVO4 laser crystal, that as a result produces 1064 nm output light. However this light is immediately doubled inside a non-linear KTP crystal, resulting in a green light at the half-wavelength of 532 nm. This beam length is next expanded and infrared-filtered. In cheap laser structures the IR filter is omitted.

The most of the semiconductor light sources are equipped with integrated lenses system at the output. As a result the output beam of both LEDs and LDs is respectively collimated to adjust properly both axis (optical as well as geometrical) to be parallel as in Fig.1.2. Otherwise the correct operation of any semiconductors light source would be missed.

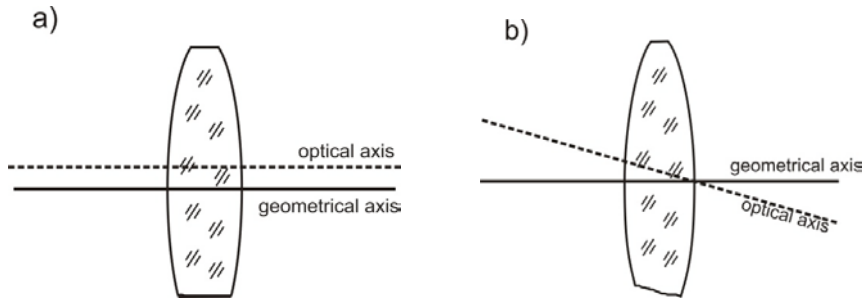
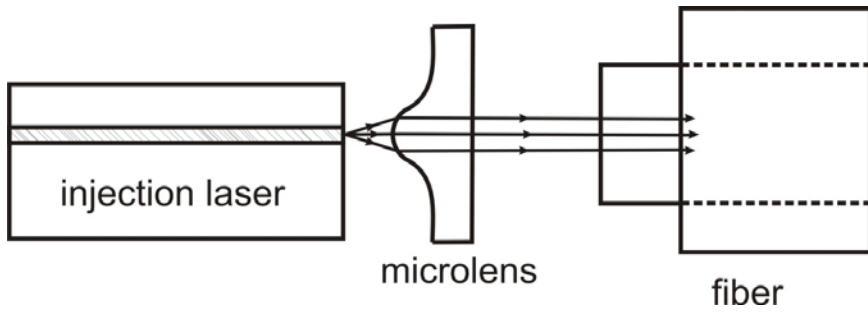

Fig. 1.2. Explanation of the collimation effect a) correct, b) incorrect

2. Investigation of radiation characteristics of semiconductor laser

The radiation characteristics (the far field distribution of the light) for two selected semiconductor lasers (green and red) shall be measured by means of optical arrangement being set-up as illustrated in Fig.2.1.

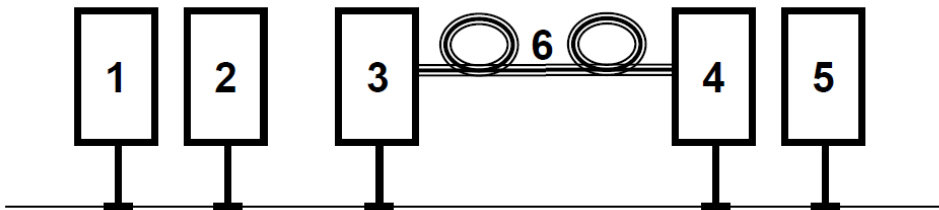

Fig.2.1. Schematic of the optical set-up for measurements

1. Source of monochromatic light – RED LASER.
2. Source of monochromatic light – GREEN LASER.
3. Rotary table.
4. Detector.

- 5. Voltmeter or oscilloscope.
- 6. Selected and specially prepared fiber guide.

2.1. Testing procedure

- turn the equipment on (red light laser and optical detector system),
- adjust the equipment operation conditions to provide both maximum and minimum value at the output of the fotodetector (it is measured by voltmeter),
- control the lateral angular characteristic of the laser and adjust the angle to be equal to 0, a half, and maximum optical power value (at the output) respectively. Repeat the testing procedure at last three times to calculate the average value.
- next, move away the detector from the laser source (on the optical bench) at selected new, longer distance and repeat the measurements as in the step mentioned above. Perform the test for at least three different the detector-laser distances.
- Execute the measurements for both red and green light lasers to compare results.

The investigated results put into respective Table (2.1 and/or 2.2).

Table 2.1. Results for the red laser

a) distance: 60cm.

U [mV]		310	450		
U [p.u]		0.68	1		
Θ [degree]	-2	-1	0	1	2

b) distance: 40cm.

U [mV]					
U [p.u]					
Θ [degree]			0		

c) distance: 20cm.

U [mV]					
U [p.u]					
Θ [degree]			0		

Table 2.2. Results for the green laser

a) distance: 60cm.

U [mV]					
U [p.u]					
Θ [degree]			0		

b) distance: 40cm.

U [mV]					
U [p.u]					
Θ [degree]			0		

c) distance: 20cm.

U [mV]					
U [p.u]					
Θ [degree]			0		

The p.u. of voltage is referred to maximum U_{\max} value of the laser output as follows:

for example for the red laser:

$$U_{MAX} = 450.0 \text{ mV}$$

therefore, for the measured value:

$$U_i = 310.0 \text{ mV}$$

the U expressed in [p.u.] is equal to:

$$U[p.u.] = \frac{U_i[mV]}{U_{MAX}[mV]} = \frac{310.0[mV]}{450.0[mV]} = 0.68[p.u.] \quad (2.1)$$

On the basis of the investigated results plot respective characteristics and compare with this presented in Fig.2.2. Specify respective conclusions.

Lateral angular characteristics of the red light laser

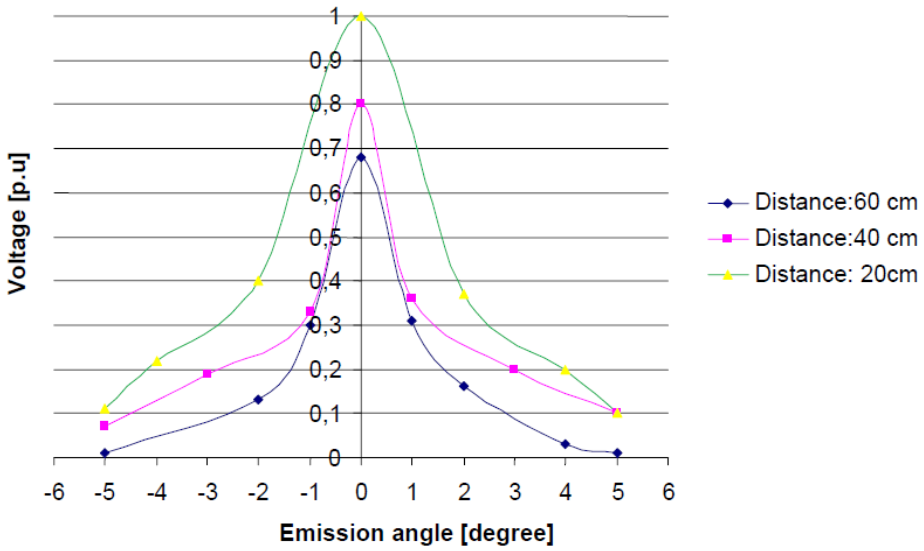

Lateral angular characteristics of the green light laser

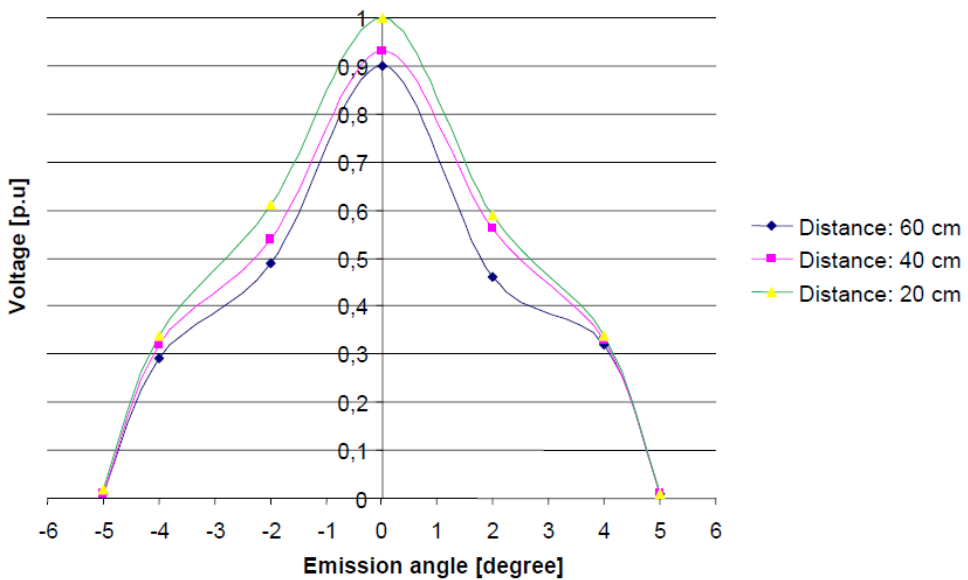

Fig.2.2. Far field distribution of the light emission for two selected semiconductor lasers (green and red)

TASK No. 5

INVESTIGATION OF OUTPUT SPECTRUM AND LIGHT-CURRENT CHARACTERISTICS OF OPTICAL LIGHT SOURCE

Concise specification (manual)

1. Introduction

Light - emitting diode (LED) is a semiconductor device composed of two types semiconductors: p-type and n-type respectively creating a semiconductor p-n junction. The semiconductor junction is a metallurgically formed single-crystal alloy of two semiconductor materials. There are two types of the junctions:

- p-n homojunction is formed with n- and p-types of the same host material (e.g. Si),
- p-n heterojunction – of different materials.

By applying external sources of energy (electrical, optical, etc) electrons and holes are created in excess of the equilibrium densities. If the p-n junction is forward-biased it means that external potential is applied to reduce the barrier potential and allows easier drift of electrons and holes (see Fig.1.1).

Therefore, the recombination of carriers is performed and energy is released in term of radiation:

$$W = E_g = h \cdot f \quad (1.1)$$

where: f – frequency of radiation; h – Plank's constant ($6.626 \cdot 10^{-34}$ Js)

Thus the wave – length λ to be emitted is:

$$\lambda = \frac{h \cdot c}{E_g} \quad (1.2)$$

where: c – speed of light in a free space; E_g in [eV]; λ in [μm].

Depending on the band gap energy E_g value one can produce the wave length in some (however, limited) range as it is presented in Table 1.1.

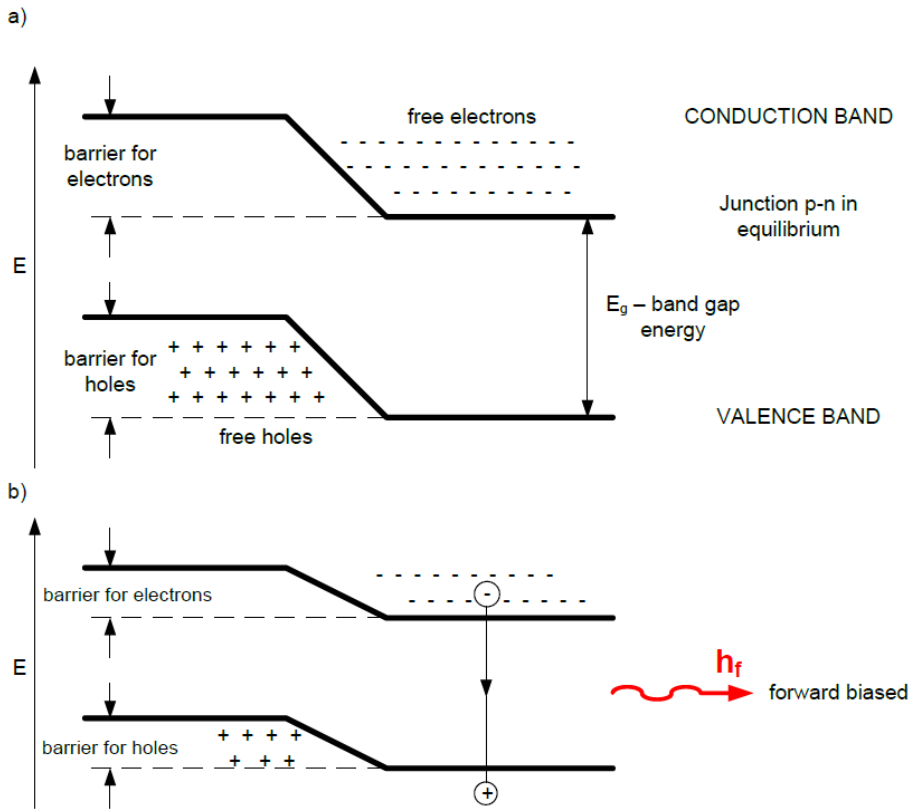

Fig.1.1. Explanation of the LED performance a) junction in equilibrium b) when forward biased

Table 1.1. Variation of the wave length with gap energy

Material	Band gap energy E_g [eV]	Wave λ [μm]
GaAs	1.4	0.9
AlGaAs	1.4÷1.55	0.8÷0.9
InGaAs	0.95÷1.55	1.0÷1.3
InGaAsP	0.73÷1.35	0.9÷1.7

There are two basic types of the LED's: surface (planar, dome) emitting diodes and edge-emitting diodes. The p-n homojunction light emitting diodes (see Fig.1.2) produce

scattered radiation (both from the surface as well as from the edge). It results in poor coupling efficiency with the fiber guide.

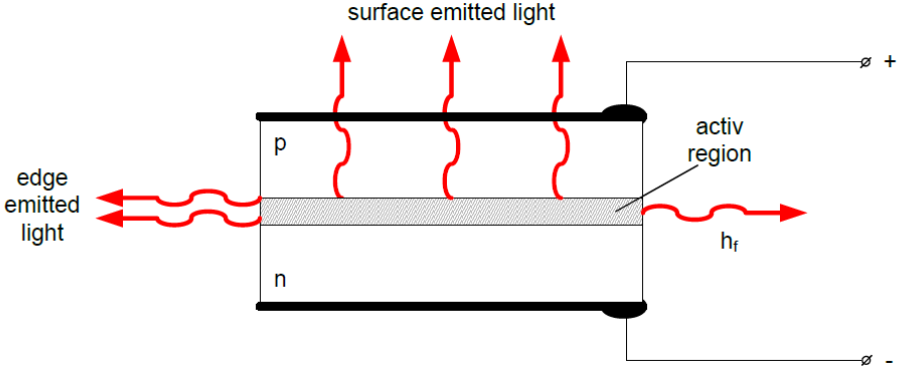

Fig.1.2. P-N homojunction LED

Therefore, much better coupling properties are found for the planer LEDs however, with p-n heterojunctions. Typical surface emitter (Burrus type) is presented in Fig.1.3.

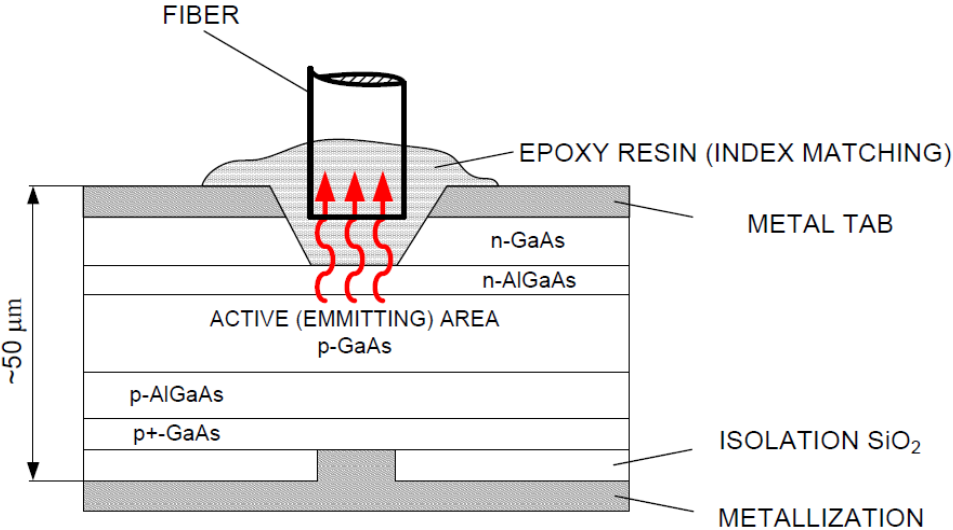

Fig.1.3. Surface emitter (Burrus type) heterojunction LED

The best for coupling are the edge-photodiodes. They provide reduced beam width and although the emitting area of an edge-emitting LED is normally less than that of the surface emitter, actually more absolute power can be coupled into the fiber with numerical aperture $NA \leq 0.3$ (SMFs). The LEDs are linear light-current devices indicating however, the incoherent emission of a wide out-put spectrum (see Fig.1.4).

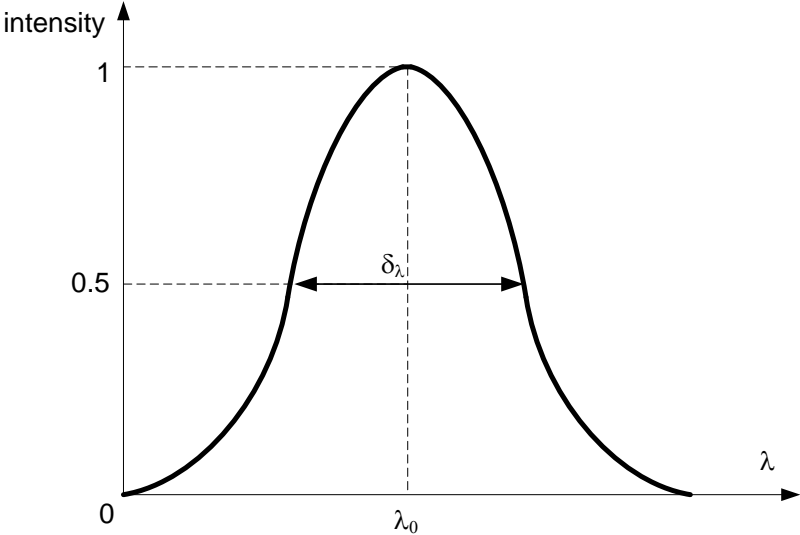

Fig.1.4. Out-put spectrum of LED

e.g.:

- | | |
|---|--|
| $\lambda_0 \sim 0.8 \div 0.9 \mu\text{m}$ | $\delta_\lambda \sim 20 \div 40 \text{ nm}$ |
| $\lambda_0 \sim 1.0 \div 1.7 \mu\text{m}$ | $\delta_\lambda \sim 50 \div 100 \text{ nm}$ |

They also indicate variation of the λ_{peak} shift with temperature around $0.3 \div 0.4 \text{ nm}/^\circ\text{C}$.

The radiation characteristic is symmetrical for the surface emitting LED indicating nonsymmetrical radiation intensity for the edge emitting LED as illustrated for example in Fig.1.5. On the contrary, lasers produce highly coherent emission of a narrow spectra with the light amplification. However, they are threshold devices (driving current has to be over current threshold value) and are sensitive to temperature. Therefore the temperature compensation is obligatory for reliable operation.

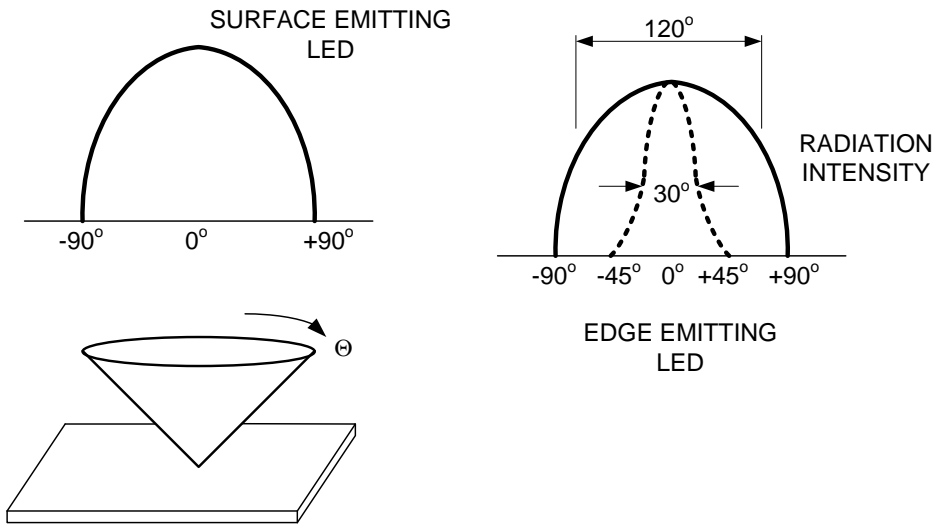

Fig.1.5. Radiation characteristics of the LEDs

2. Testing arrangement

To control the output spectrum and the light-current characteristics of both LED and LD diodes a spectrophotometer has to be used (Fig.2.1). Schematic of the set-up for testing is indicated in Fig.2.2.



Fig. 2.1. View of the spectrophotometer applied

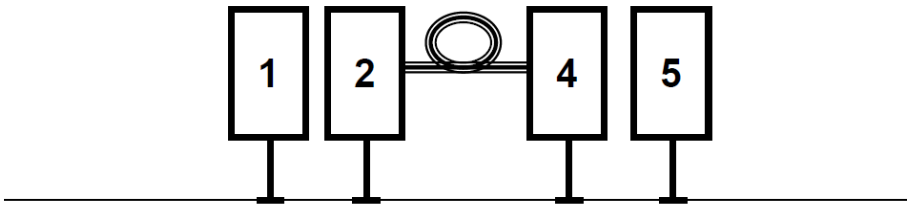

Fig.2.2. Schematic of the optical setup for measurements; 1. Light source, 2. ST standard connectors, 3. Specially selected fiber optics, 4. Spectrophotometer, 5. Computer with software.

2.1. Testing procedure

Two types of light emitting sources are selected for testing: Light emitting diodes (LEDs) and laser diodes (LDs) respectively. The measurements are to be carried out as follows:

- power the whole equipment on (computer with software, spectrophotometer and optical source system),

- measure the out-put spectrum for all diodes selected at maximum driving current value. Control the wave length (beginning, maximum intensity and end of spectral width) and the radiation intensity (example of the measured spectrum for ordinary bulb is given in Fig. 2.3),
- measure the out-put spectrum for the sun light and for commonly used light sources (bulb, glow-discharge tube) and compare with this for the LED generating the white light (conduct the testing at similar way and range as at above mentioned point),
- repeat the measurements as above but only for selected LEDs and LDs to control the light-current characteristics. The driving current value must be changed in wide range (from minimum to maximum) of specified control values of the particular light source,
- try to control the spectrum of the multimode – RGB LED to obtain the visible white light.

The investigated results list in respective Tables (as for example in Table 2.1 for the red light LD). On the basis of the investigated results plot both output spectrums and light-current characteristics for the light sources investigated (some examples for comparison are presented in Fig.2.3. ÷ Fig.2.5. Specify conclusions.

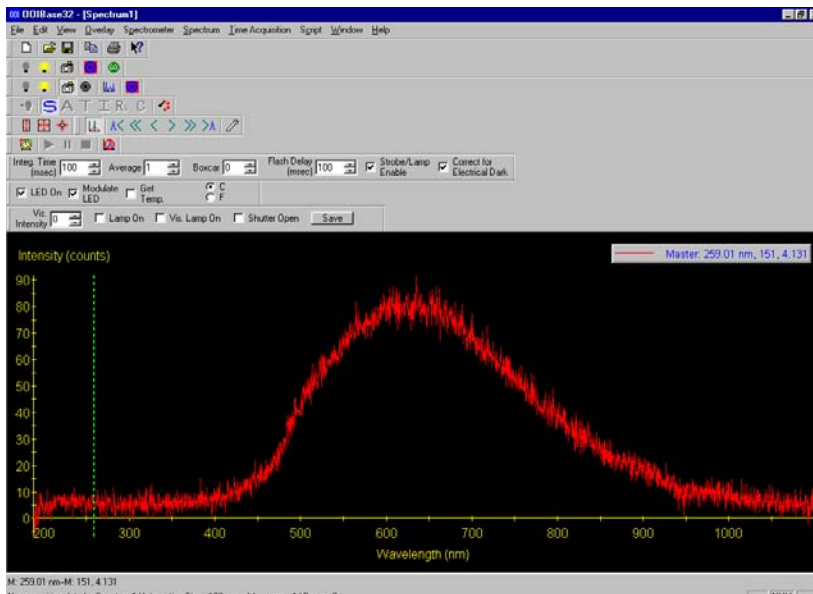

Fig. 2.3. Example of output spectrum for ordinary bulb (incandescent lamp)

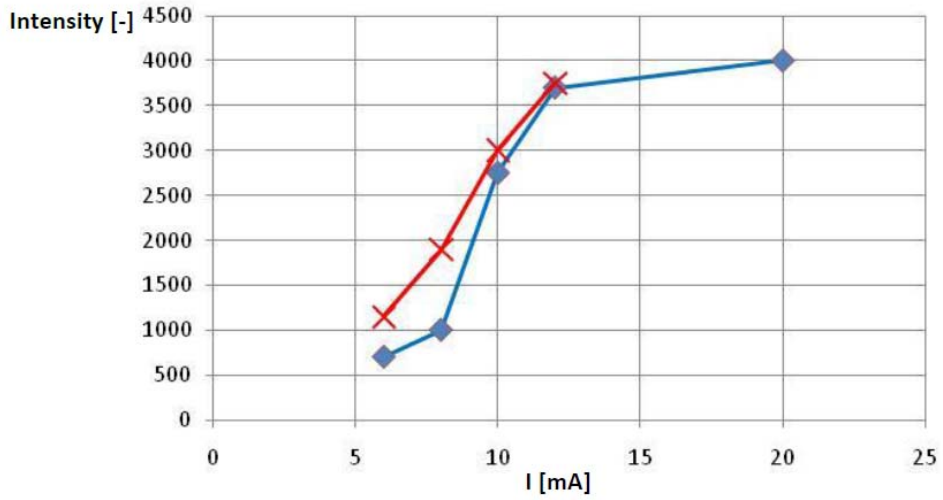

Fig.2.4. Light-current characteristic for LED and LD (x - intensity of laser diode LD, \diamond - intensity of red LED)

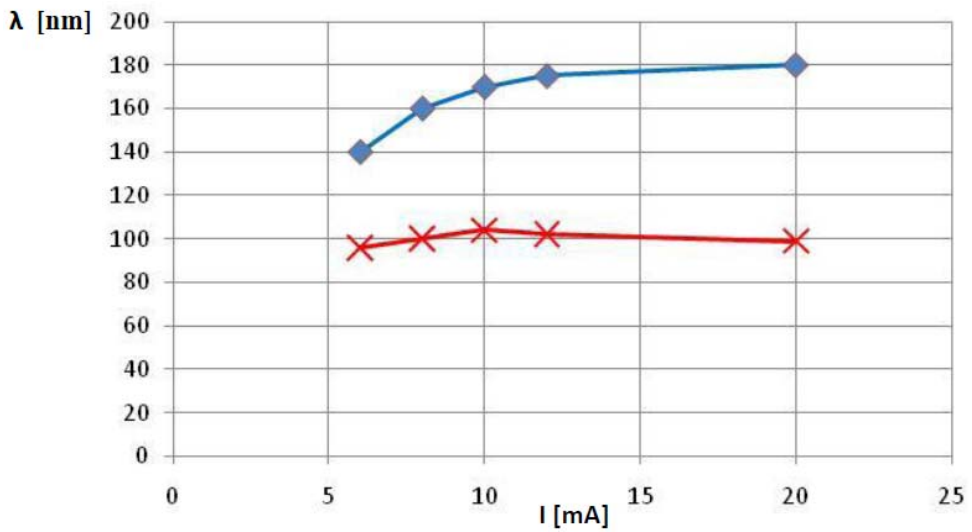

Fig.2.5. Wave-length versus driving-current (x – wave length of laser diode, \diamond – wave length of red diode)

Table 2.1. Results of measurements for red light LD

			wave length			
No.	Intensity	Current	start	max	stop	remarks
[-]	[-]	[mA]	[nm]			
1.						
2.						
3.						

TASK No. 6
INVESTIGATION OF MATCHING EFFICIENCY OF OPTICAL
CONNECTORS

Concise specification (manual)

1. Introduction

In fiber optical transmission systems the connectors are among others elements very important passive components. They are needed both, to extend the fiber length (single fiber length is up to about 1 km) and/or to provide communication link between the fiber guide and various measuring and controlling as well as metering equipments. There are two basic types of connections in use: fiber splices (semi-permanent and/or permanent joints) and fiber connectors (non-permanent/demountable). It is extremely difficult to make a perfect joint since, the losses at connection area are unavoidable. One distinguishes here so called intrinsic (immanent) losses related strictly to internal properties and manufacturing technology and extrinsic losses which are introduced from outside due to assembling. The air gap usually exists between two separated parts of the fiber guides being connected therefore, due to involved fiber – air interfaces, there are losses generated due to the rays reflection from the interfaces (leaky modes). These losses are described by Fresnel formula:

$$r = \left(\frac{n_f - n_0}{n_f + n_0} \right)^2 \quad (1.1)$$

where: r – fraction of light reflected at the interface,

n_f – core refractive index,

n_0 – air refractive index (equal to 1).

$$l_{\text{lossFresue}} = 10 \log(1 - r) \quad (1.2)$$

The intrinsic losses are due to such parameters as:

- core diameter differences,
- numerical aperture differences,
- core-cladding eccentricity,
- index profile mismatching (for the graded-index fibers),

The extrinsic losses are due to:

- transverse offset between fiber cores,
- fiber and separation,
- angular misalignment,
- nonsmooth end surface.

Regarding the splice techniques, the most prominent one is the fusion splicing using electric arc or laser heating. The connectors are offered as lens-coupled as well as butt-coupled (without lenses). There are different types of butt-coupled connectors e.g. screwed onto the optoelectronic transducer, modular style mounting system and for multi-contact strips etc. To decrease the contact losses the special index-matching liquid or epoxy can be used to fill the gap.

Another problem that influences the degradation of quality of the fiber optics transmission is dispersion. The dispersion is a collective term for all effects producing delay differences and therefore limiting the transmission bandwidth of the fiber. In MMFs dominates intermodal dispersion that is due to the differential time delay between modes at a single frequency. While, the intramodal (chromatic) dispersion results from the variation of group velocity of a particular mode with wavelength. It plays a significant role in SMFs as only one mode is propagating. The chromatic dispersion presents the combined effect of material and waveguide properties of the fiber string. However, the influence of the material dispersion is much higher in comparison to this of the waveguide. In practice also the spectral source's width affects the overall dispersion thus, the group delay time. As a result the bit rate (B_T) as well as the bandwidth-length product ($B_L \cdot L = \text{const}$) is limited, due to the total pulse spread (the dispersion coefficient is expressed both in terms of pulse spread and/or in terms of bandwidth). Quality of the optical fiber system transmission is strongly affected by the photodetector properties. A good photodetector should be characterised:

- high efficiency,
- sensitive and fast response,
- low noise,

Speed of response is limited by diffusion and drift time, as well as by the junction capacitance. The total response time is also influenced by quality of the completed photodetection system.

As a result, to fulfill requirements for high transmission efficiency all the system elements and components should be carefully selected and matched to the wave length applied.

2. Investigations of the matching efficiency

Schematic diagram of the measuring system is shown in Fig.2.1. It is composed of the optical transmission unit, the frequency generator and the fotodetector unit with the output oscilloscope.

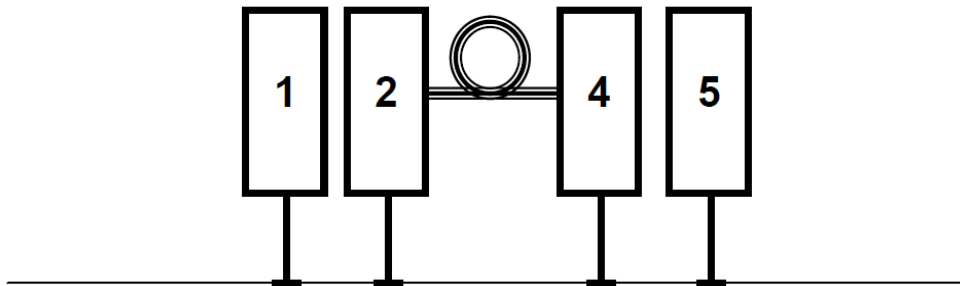

Fig.2.1. Block scheme of the testing circuit; 1. Electrical function generator, 2-4. Optical track based on ST standard connectors with gap measuring equipment, 5. Oscilloscope.

2.1. Testing procedure

- power the optical transmission system together with the frequency generator and oscilloscope,
- select required optical transmission system and set-up the air gap (between the fiber guide and connector) to its minimum value while, recording the received output pulses,
- adjust the gap length to its maximum value and control the output pulses respectively,
- test the output pulse characteristic under variation of the gap length value from its minimum to maximum,
- repeat the measurements for different (selected in a whole range) frequencies,
- select another optical tract and repeat the whole test.

All the investigated data set-up in Table 2.1 and Table 2.2 and plot respective characteristics: dependence of the output pulse value (under the variable gap length

between fiber guide and connector) on the fiber-connector distance and the time delay of the pulse versus frequency.

Table 2.1. Output pulse value for different air gap length (f=5kHz=const)

No	l	U	U
[-]	[μm]	[V]	[p.u.]
1.			
2.			

Table 2.2. Time delay of the output pulse as a function of frequency for fixed minimum (17 μm) gap length value

No	f	t ₁₍₁₎	t ₂₍₁₎	$\Delta t_{12(1)}$	t ₁₍₀₎	t ₂₍₀₎	$\Delta t_{12(0)}$
[-]	[kHz]	[μs]	[μs]	[μs]	[μs]	[μs]	[μs]
1.							
2.							

t₁₍₁₎-pulse rise time at input; t₂₍₁₎-rise time at the output;
 t₁₍₀₎- pulse fall time at input (generator); t₂₍₀₎- fall time at the output.

Compare the obtained characteristics with the reference characteristics presented in Fig.2.2 ÷ Fig.2.4.

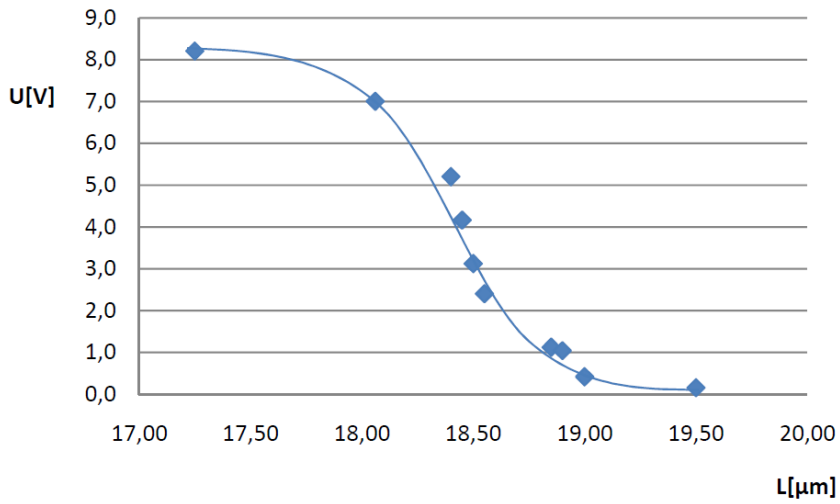

Fig.2.2. Output pulse value versus air gap length

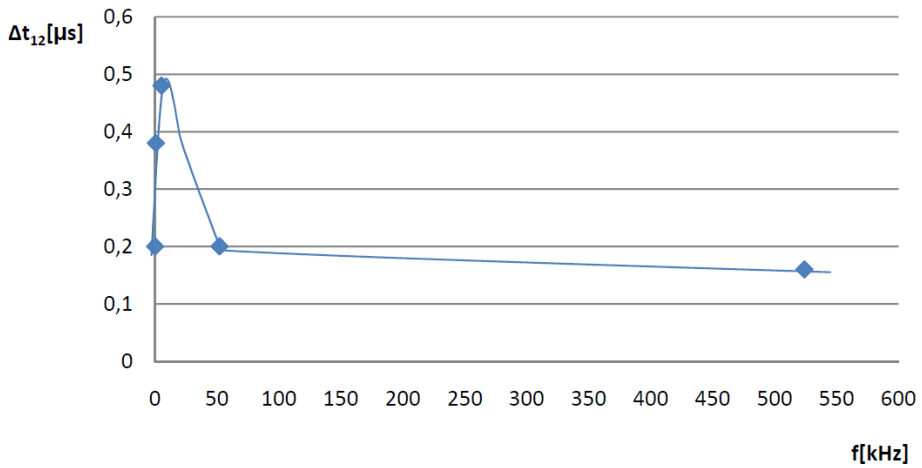

Fig.2.3. Variation of the difference time between the pulse rise time at input and output changing frequency

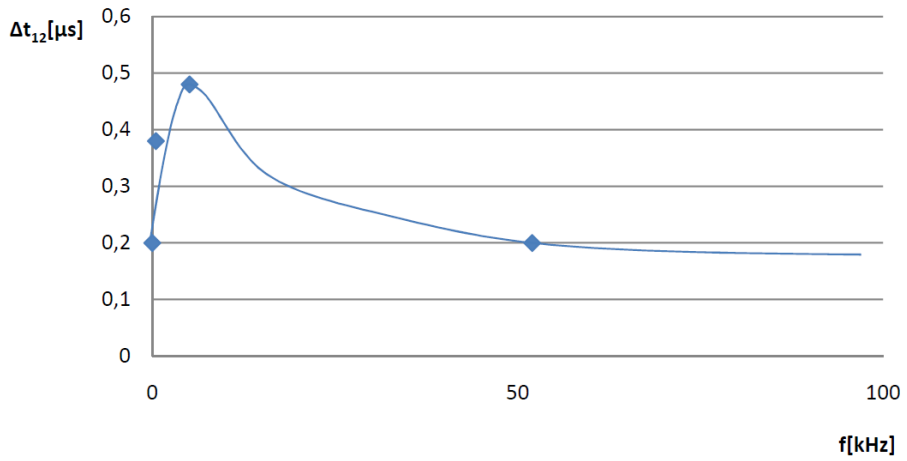

Fig.2.4. Selected area of characteristic from Fig.2.3

On the basis of the results specify respective conclusions.

References

- [1] <http://en.wikipedia.org/wiki/Laser>
- [2] Chai Yeh: Handbook of Fiber Optics. Theory and Applications Academic Press Inc
2006.
- [3] CIGRE WORKING GROUP 35.04: Optical Fiber Cable Selection for Electricity
Utilities; February 2001.
- [4] R.M. Gagbiardi, Sh. Karp: Optical Communications. Willey Interscience Publications
2007.