



KAPITAŁ LUDZKI
NARODOWA STRATEGIA SPÓJNOŚCI



Politechnika Wroclawska

UNIA EUROPEJSKA
EUROPEJSKI
FUNDUSZ SPOŁECZNY



ROZWÓJ POTENCJAŁU I OFERTY DYDAKTYCZNEJ POLITECHNIKI WROCŁAWSKIEJ

Wrocław University of Technology

Environmental Quality Management

Małgorzata Kabsch-Korbutowicz
Katarzyna Majewska-Nowak

MEMBRANE SEPARATION PROCESSES IN ENVIRONMENTAL PROTECTION

Wrocław 2011

Projekt współfinansowany ze środków Unii Europejskiej w ramach
Europejskiego Funduszu Społecznego

Wrocław University of Technology

Environmental Quality Management

Małgorzata Kabsch-Korbutowicz
Katarzyna Majewska-Nowak

MEMBRANE SEPARATION PROCESSES IN ENVIRONMENTAL PROTECTION

Wrocław 2011

Copyright © by Wrocław University of Technology
Wrocław 2011

Reviewer: Jacek Wiśniewski

ISBN 978-83-62098-72-9

Published by PRINTPAP Łódź, www.printpap.pl

CONTENTS

| | |
|-----------------------------------------------------------------------------------|----|
| 1. INTRODUCTION | 5 |
| 2. MEMBRANE TYPES | 6 |
| 2.1. Natural membranes | 6 |
| 2.2. Synthetic membranes | 7 |
| 3. CLASSIFICATION OF MEMBRANES AND MEMBRANE OPERATIONS | 9 |
| 3.1. Definition of membranes | 9 |
| 3.2. Classification of membranes | 11 |
| 3.2.1. <i>Classification according to membrane material</i> | 11 |
| 3.2.1.1. <i>Polymeric membranes</i> | 11 |
| 3.2.1.2. <i>Inorganic membranes</i> | 17 |
| 3.2.2. <i>Classification according to separation mechanism</i> | 20 |
| 3.2.3. <i>Classification according to membrane structure and morphology</i> | 20 |
| 3.2.4. <i>Classification according to membrane geometry</i> | 22 |
| 4. MEMBRANE PREPARATION | 23 |
| 4.1. Phase inversion technique | 23 |
| 4.2. Track-etching | 24 |
| 4.3. Stretching | 25 |
| 4.4. Sintering | 26 |
| 5. BASIC PARAMETERS OF MEMBRANE PROCESSES | 26 |
| 5.1. Membrane characterization | 26 |
| 5.2. Evaluation of membrane performance | 30 |
| 6. CHARACTERISTICS OF MEMBRANE PROCESSES | 32 |
| 6.1. Pressure driven membrane processes | 32 |
| 6.1.1. <i>Microfiltration</i> | 35 |
| 6.1.2. <i>Ultrafiltration</i> | 37 |
| 6.1.3. <i>Nanofiltration</i> | 39 |
| 6.1.4. <i>Reverse osmosis</i> | 40 |
| 6.2. Chemical potential driven membrane processes | 42 |
| 6.2.1. <i>Dialysis</i> | 43 |
| 6.2.2. <i>Gas or vapor permeation</i> | 44 |
| 6.2.3. <i>Pervaporation</i> | 47 |
| 6.2.4. <i>Liquid membranes</i> | 50 |
| 6.3. Thermal potential driven membrane processes | 52 |
| 6.3.1. <i>Membrane distillation</i> | 52 |
| 6.4. Electrical potential driven membrane processes | 55 |
| 6.4.1. <i>Electrodialysis</i> | 55 |

| | |
|------------------------------------------------------------------------------------|------------|
| 6.4.2. <i>Electrodialysis reversal</i> | 66 |
| 6.4.3. <i>Electrodialysis with bipolar membranes</i> | 67 |
| 6.4.4. <i>Electrodeionization</i> | 69 |
| 7. MASS TRANSPORT AND PERMEATE FLUX CHANGES IN MEMBRANE PROCESSES | 71 |
| 7.1. Concentration polarization in pressure driven membrane processes | 73 |
| 7.2. Membrane fouling in pressure driven membrane processes | 74 |
| 7.3. Concentration polarization in electrodialysis | 80 |
| 8. MEMBRANE SYSTEM OPERATION | 82 |
| 8.1. System operation modes | 82 |
| 8.2. Operating configurations | 84 |
| 9. MEMBRANE MODULES | 86 |
| 9.1. Plate-and-frame module | 87 |
| 9.2. Spiral-wound module | 88 |
| 9.3. Tubular module | 89 |
| 9.4. Capillary and hollow fiber modules | 90 |
| 10. APPLICATION OF MEMBRANE PROCESSES IN ENVIRONMENTAL PROTECTION | 92 |
| 10.1. Water | 92 |
| 10.1.1. <i>Water desalination</i> | 93 |
| 10.1.2. <i>Treatment of mine waters</i> | 107 |
| 10.1.3. <i>Water demineralization</i> | 109 |
| 10.1.4. <i>Drinking water production by natural water treatment</i> | 117 |
| 10.2. Wastewater | 121 |
| 10.2.1. <i>Treatment of oil emulsions</i> | 121 |
| 10.2.2. <i>Regeneration of electrophoretic painting baths</i> | 123 |
| 10.2.3. <i>Water and chemical reuse in the textile industry</i> | 123 |
| 10.2.4. <i>Whey processing</i> | 128 |
| 10.2.5. <i>Recovery of metals from industrial effluents</i> | 131 |
| 10.2.6. <i>Membrane bioreactors</i> | 133 |
| REFERENCES | 137 |

1. INTRODUCTION

The word membrane comes from the Latin word *membrana* meaning skin. Today, the word *membrane* has been extended to describe a thin, flexible sheet or film acting as a selective layer between two phases due to its semi permeable properties. Physically, a membrane can be a solid or a liquid. The primary function of membranes is to act as a separation agent having very selective properties based on the difference in the diffusivity coefficient, electric current or solubility.

Because of the advances in membrane technology in the second half of the 20th century, membranes are regularly used in many aspects of life (Fig. 1-1). Membrane separation technologies are used in diverse applications ranging from the production of potable water, wastewater treatment and processing of water, to tissue repair, power generation, processing of food and beverages, therapeutic procedures and the production of pharmaceuticals.

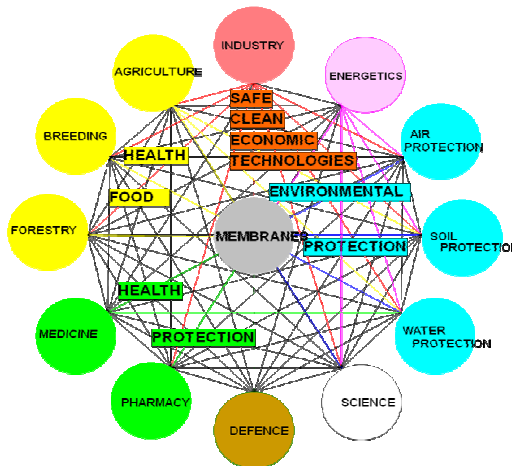

Fig. 1-1. Areas in which membrane processes are applied (based on [1])

Membrane separation processes are used in numerous industrial applications and have the following advantages:

- appreciable energy savings,
- environmentally benign,
- clean technology with operational ease,
- replaces conventional processes such as filtration, distillation, ion-exchange and chemical treatment systems,
- produces high-quality products,
- greater flexibility in system design,

- compact operations,
- easy scale-up,
- automatic operation.

2. MEMBRANE TYPES

2.1. Natural membranes

All living things need membranes to survive. When life appeared on the Earth approximately 4 billion years ago, the first microorganisms had to create a barrier for protecting the cell from the actions of factors harmful to the organism and for maintaining the substances produced by bacteria itself as a result of metabolic activity.

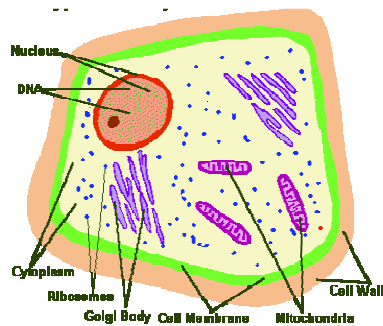

Fig. 2-1. Eukaryote cell (based on [2])

Along the evolutionary road, prokaryotic and eukaryotic organisms created a cell membrane (Fig. 2-1) whose specific characteristics allowed for the transportation into the cell of selected components indispensable for development as well as for the elimination of outside toxic metabolites. The cell membrane is made mostly from a double layer of lipids (hydrophobic fat-like molecules) and hydrophilic phosphorus molecules (Fig. 2-2). Hence, the layer is called a phospholipid bilayer. It may also be called a fluid mosaic membrane. Embedded within this membrane is a variety of protein molecules that act as channels and pumps moving different molecules into and out of the cell. The membrane is said to be 'semi-permeable' in that it can either let a substance (molecule or ion) pass through freely, pass through to a limited extent or not pass through at all. Cell surface membranes also contain receptor proteins that allow cells to detect external signaling molecules such as hormones.

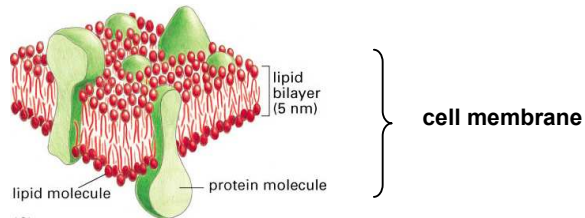

Fig. 2-2. The structure of the cell membrane (based on [3])

Actually membranes has become an integral part of our daily lives. All cells composing living things, including ours are surrounded with membranes.

Biological membranes:

- isolate the inside of the cell from the outside environment maintaining the order of the cell,
- regulate the movement of materials into and out of the cell,
- compartmentalize the interior of cells allowing for the creation of specialized regions within the cell,
- provide a site for many chemical reactions – on or within membranes,
- serve as a site of chemical receptors – provide information about the outside environment,
- serve as a site of many chemical identifiers – provide information about the cell to other cells.

2.2. Synthetic membranes

Over time, mankind, looking to nature as a guide, began to create selective membranes which due to their own specific properties only permeate certain liquid or gas elements while simultaneously establishing an impermeable barrier to other elements.

Research into membranes and phenomena related to the transportation of solution elements was already carried out in the 18th and 19th centuries. The first known work on the subject of membranes was by the French monk Jean Antoine Nollet, who in 1748 described the phenomena of water transport across an animal membrane [4]. The term *osmosis* was coined by the French Physiologist Henri du Trochet 80 years after Nollet made the discovery of the phenomenon [5]. In subsequent years, research conducted throughout the world enabled new techniques of membrane separation. Key developments and years in the field of membranes and membrane processes are given in Table 1.

Table 1. The milestones in membrane science (based on [1])

| | | |
|-------------------------------------------------------|------|---------------------------------------------------------------------------------|
| Jean Antoine Nollet | 1748 | discovering of osmosis phenomenon in natural membranes |
| Carlo Matteucci | 1845 | research on anisotropy of natural membranes |
| Thomas Graham | 1866 | research on dialysis; research on gas separation on rubber polymer membranes |
| Adolf Eugen Fick | 1865 | the first synthetic membrane from nitrocellulose; |
| Moritz Traube | 1867 | research on osmosis on synthetic membranes |
| Wilhelm Pfeffer | 1877 | research on osmosis on ceramic membranes |
| Josiah Willard Gibbs and Jacobus Henricus van 't Hoff | 1877 | theory of osmosis phenomena |
| Frederick George Donnan | 1911 | works on membrane equilibrium describing ionic transport in cells |
| John J. Abel and Georg Haas | 1913 | the first description of hemodialysis procedure |
| George R. Elder | 1934 | research on electro dialysis |
| Karl Kammermeyer | 1957 | research on gas separation on silicone rubber membrane |
| Harold Lonsdale | 1960 | research on composite membranes |
| Sydney Loeb and Srinivasa Surirajan | 1962 | preparation of asymmetric membrane |
| Henry Mahon | 1966 | preparation of hollow-fiber membranes |
| Oliver H. LeBlanc, | 1980 | description of facilitated transport in membranes |
| Robert Rautenbach | 1990 | description of hybrid processes |

Unfortunately, in the early years of membrane science a lack of membranes with permanent, well-defined properties greatly limited their common application. A breakthrough in the development of membrane techniques, and especially in pressure driven separation processes used for the purification of water and wastewater, was made by Loeb and Sourirajan, who in 1958-1962 discovered how to make asymmetric membranes with controlled pore sizes.

3. CLASSIFICATION OF MEMBRANES AND MEMBRANE OPERATIONS

3.1. Definition of membranes

Membranes act as a selective barrier allowing specific substances to pass through while retaining others. The ability of membranes to differentiate amongst substances is called membrane *selectivity*. Membranes can be used for solute-solvent, solute-solute, particle-solute and particle-solvent separation.

According to the definition formulated by The European Membrane Society, a membrane is an intervening phase separating two phases and/or acting as an active or passive barrier to the transport of matter between the phases adjacent to it.

A membrane process is an operation where the feed stream is divided into two streams: a permeate and retentate. Permeate is the stream passing through the membrane while retentate is the stream retained by the membrane. The main idea of membrane separation is presented in Fig. 3-1.

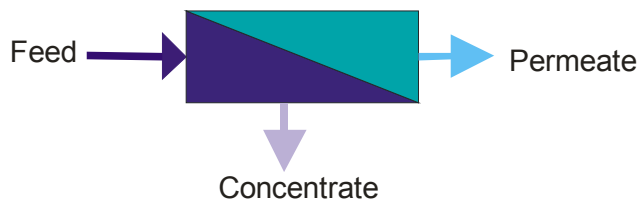

Fig. 3-1. The principle of membrane separation

Depending on the purpose of the membrane application each stream might be the final product (Fig. 3-2). Membrane operation can be used to concentrate or to purify a solution or a suspension and to fractionate a mixture.

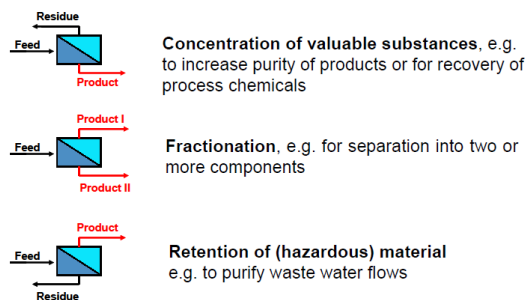

Fig. 3-2. Principle strategies of membrane filtration

Mass transport through membranes is possible due to the application of a driving force (Fig. 3-3). In most cases, the driving force is either a pressure difference (ΔP), a chemical potential (concentration) difference (ΔC), a temperature difference (ΔT) or an electrical potential difference (ΔE).

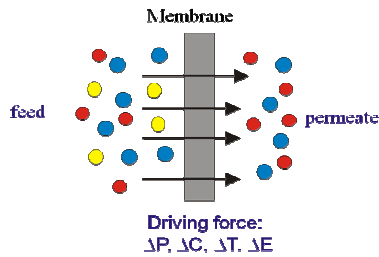

Fig. 3-3. Mass transport through a membrane

A general classification of membrane operation can be obtained by considering the following parameters:

- driving force,
- mechanism of separation,
- membrane structure,
- phases in contact.

The most common membrane process classification concerns the driving force. Based on this criterion, there are 4 groups of membrane processes (Table 2).

Table 2. Driving forces and their related membrane separation processes

| <i>Driving force</i> | <i>Membrane process</i> |
|---------------------------------|------------------------------------------------------------------------------------------|
| pressure difference | microfiltration, ultrafiltration, nanofiltration, reverse osmosis or hyperfiltration |
| chemical potential difference | pervaporation, pertraction, dialysis, gas separation, vapor permeation, liquid membranes |
| electrical potential difference | electrodialysis, membrane electrophoresis, membrane electrolysis |
| temperature difference | membrane distillation |

3.2. Classification of membranes

There are several classification schemes for membranes. The most popular are classifications based on

- material (organic, inorganic),
- separation mechanism (sieve, solubility-diffusivity, charge interactions),
- structure and morphology (symmetric, asymmetric),
- configuration (flat, tubular).

3.2.1. Classification according to membrane material

In principle, all types of materials can be used as membranes. However, the selection of a material is dependent on the cost, the separation task, the desired structure of the membrane and the operating conditions under which it has to perform. Membrane materials are normally divided into biological and synthetic (Fig. 3-4). Man-made membranes are made of organic or inorganic materials; however, currently organic membranes dominate. Some membranes are hybrid membranes using both polymer and inorganic materials.

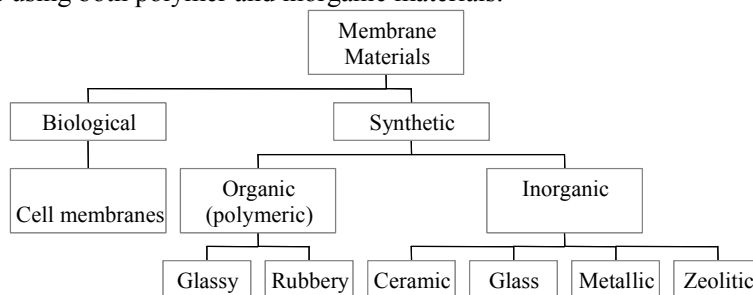

Fig. 3-4. Membrane materials

3.2.1.1. Polymeric membranes

The most commonly used membrane materials are organic polymers. There are a large number of polymer materials available. The most commonly used polymers are [6]:

- Polysulfone (PS),
- Polyethersulfone (PES),
- Cellulose acetate (CA),
- Regenerated cellulose,
- Polyamides (PA),

- Polyvinylidenfluoride (PVDF),
- Polyacrylonitrile (PAN),
- Polypropylene (PP).

According to The Freedonia Group Report [7], 93% of membranes sold in the US in 2011 will be made of polymeric materials. Among them, 58.5 % of membranes will be made of cellulosic materials while 30.3 % of polysulfone and nylon.

Some of the advantages of polymers are flexibility, permeability and ability to be formed into a variety structures. On the other hand, polymers are generally not thermally stable, which can be a problem for many separation tasks. Fig. 3-5 presents the chemical and thermal stability of polymeric membranes.

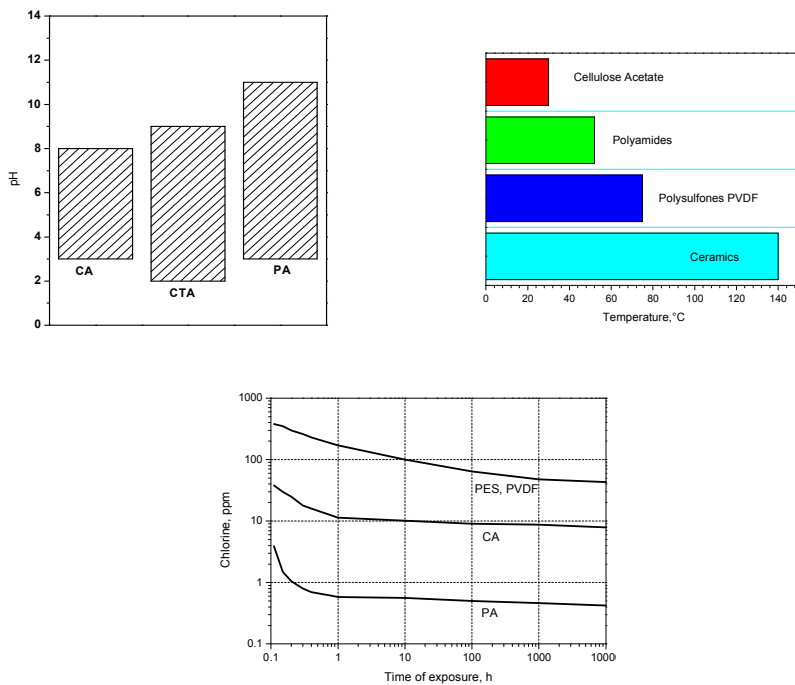

Fig. 3-5. Chemical stability of membrane materials (based on [8])

Hydrocarbon-Based Polymers

The most basic polymers are created from vinyl monomers ($H_2C=CHR$). The simplest, polyethylene, is made from the polymerization of ethane to form a saturated carbon chain. In the case of polyethylene, the R-group is hydrogen. The position of the R-group after polymerization has a significant effect on the properties of the polymer. Polymers with all of the R-groups on same side of the carbon chain (termed isotactic) are crystalline. Polymers with the R-groups randomly arranged on either side of the carbon chain (termed atactic) are amorphous. Polymers with R-groups regularly distributed on both sides of the carbon chain (termed syndiotactic) are partially crystalline. The strength and versatility of Polypropylenes (PP) result from a matrix of interlocking crystallites that allow the formation of rigid and tough polymer structures. Polypropylene membranes reach a limited porosity and are mainly symmetric in structure. The basic material is hydrophobic limiting the material to organic solvents or requiring a surfactant to reduce the hydrophobic influence on the membrane surface. Although the final melting point of commercial PP lies in the range of 150 - 180°C, the safer upper working temperature limit should be between 100 - 120°C, depending on the stress. The material normally starts to soften at temperatures around 80°C; thus sterilizing with hot steam (121 to 134°C) is limited. Furthermore, irradiation results in an autocatalytic degradation of the polymer which can only be inhibited by additives that reduce free radicals. PP is compatible with acidic and caustic solutions as well as with most solvents offering a broad range of applications. Only powerful oxidizing agents and highly aromatic solvents are generally considered non-compatible. PP adsorbs some solvents leading to a swelling of the PP matrix, thereby influencing the pore structure and size.

Cellulosic Polymers

Cellulose is a polysaccharide with a molecular weight up to 1,500,000. It can be formed into esters (cellulose acetate, cellulose nitrate) or into ethers (ethyl cellulose). The alcoholic hydroxyl groups of cellulose are polar and can be substituted by nucleophilic groups under strong acidic conditions. The mechanism of esterification can be applied to various agents, but mainly nitric acid or organic acids (e.g. acetic acid) are used for generating cellulose ester polymers for microporous membranes. The regular repeating linear chain leads to a crystalline structure. It is extremely hydrophilic, making it useful for aqueous based membrane processes such as kidney dialysis, microfiltration and ultrafiltration. Cellulosic membranes have also been produced with dense, nonporous skins appropriate for gas separation. Cellulosic membranes have low adsorption characteristics making them useful for biopharmaceutical processes where proteins can cause rapid fouling. However, cellulose is unstable under high pH conditions

which limit its application. This problem has been overcome by chemical stabilization and these membranes can tolerate cleaning with 1.0 N NaOH for limited time periods.

The most common cellulosic material in microfiltration is cellulose acetate (Fig. 3-6) or mixtures of cellulose nitrate and cellulose acetate. Cellulose acetate (CA) membranes are hydrophilic and stable against weak caustic and acidic solvents and stable against most mineral and fatty oils. The stability against high temperatures and physical stress combined with an extremely low unspecific adsorption of chemical entities or peptides and proteins make CA a membrane material of choice for the filtration of high value products. The CA membranes can be either symmetric or asymmetric and the physical strength can be further improved by the incorporation of support fleeces in the membrane matrix without influencing the pore structure or size.

The unique feature of cellulose nitrate (CN) is its extremely high unspecific adsorptive capabilities. Therefore, the use of cellulose nitrate in mixed ester membranes is appropriate for applications where an unspecific adsorption is desired such as in analytical, diagnostic or microbiological applications.

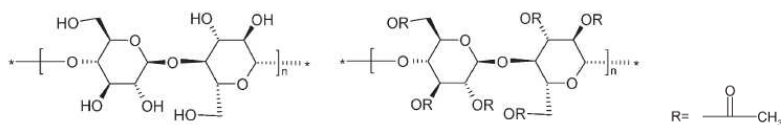

Fig. 3-6. Structure of cellulose (left) and cellulose acetate (right)

Polysulfone

Polysulfone is the generic term for all sulfone-containing polymers, which is one of the most important groups of polymers in membrane science. All commercial polysulfones used as membrane polymers are essentially amorphous and are relatively polar. They can adsorb only small amounts of water and therefore show nearly no swelling in aqueous solutions. The membrane polymer is extremely resistant to hydrolysis over the whole pH range, even in hot steam or water. Only organic solvents with a polarity similar to that of the polymer (for example: DMF, DMSO) or certain chlorinated hydrocarbons can show dissolving effects. Resistance against ionizing irradiation and thermal stability up to >200°C is excellent. The polar groups in the polysulfone chain result in a very flexible modulus and thereby robust membrane matrix.

Polysulfone (PS) and polyethersulfone (PES) (Fig. 3-7) are the most used commercial membrane polymers. They can be formed into homogenous membranes but are usually formed into porous membranes. The membranes can be either very symmetric or asymmetric or a combination of both and thereby offer

the broadest range of membrane structures. The porosity of the membrane matrix is very high, resulting in excellent filtration rates. The flexibility and the thermo-physical toughness of the base polymer combined with the high chemical compatibility offer a broad range of applications. Therefore, they can be used for microfiltration, ultrafiltration, nanofiltration or as a base support for composite membranes. They have also recently been used for hemodialysis membranes with improved biocompatibility.

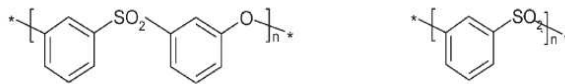

Fig. 3-7. Structure of polyethersulfone (left) and polysulfone (right)

Polyamides

Polyamides (PA) – generally characterized by the amide group as the recurring part of the chain and known as “nylons” – are widely used as base polymers for microfiltration membranes. Aliphatic polyamides (Fig. 3-8) are very common in a wide range of applications, but the aromatic polyamides are principally preferred as membrane materials due to their good chemical, thermal and physical compatibility. In particular, compatibility with most solvents makes it a membrane of choice for such filtration applications. The resistance to extreme high and low pH conditions is limited, but the toughness, fatigue and abrasion resistance make it a very robust membrane polymer. Nevertheless, the comparable low base polymer price and longtime availability on the market make the aliphatic polymers very common in microfiltration applications. Due to their weak charge, the aliphatic polyamide membranes are hydrophilic and show very high adsorption capacities. This feature can be an advantage in processes where adsorption is essential; however, it can be a disadvantage when adsorption of a target molecule results in a loss of product. The adsorption of water into the matrix leads to membrane swelling, but this does not influence the robustness of the membrane. The structure is limited to a more symmetric matrix and the porosity does not reach levels of newer PES membranes. Even with these limitations, PA-membranes are excellent filtration tools for solvents in which its chemical compatibility is advantageous.

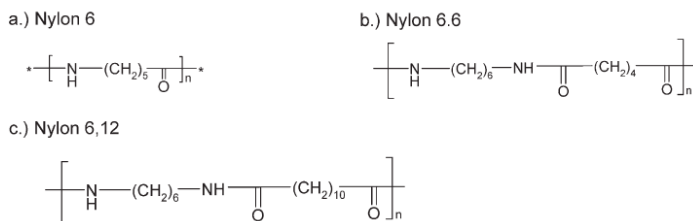

Fig. 3-8. Structures of a selection of polyamides used for membrane production

Polycarbonates

The most typical – and economically successful – polycarbonate (PC) is the bisphenol A polycarbonate (Fig. 3-9). Due to its unique combination of extreme toughness, high heat resistance, low price and high transparency, PC is one of the most common polymers for construction and device design. The chemical compatibility does not include strong acids and most halogenated and non-halogenated solvents, but it is readily compatible with water, alcohols and aliphatic solvents. Utilization as a membrane base polymer nevertheless has some limitations due to very low porosities compared to other existing polymer matrices if the membrane is produced using standard procedures such as evaporation of precipitation casting. Polycarbonates are used in the production of track-etched membranes in which a membrane is formed by irradiation of a thin film followed by etching with a strong acid. This procedure with the generated symmetric pores and membrane matrices requires a physically robust and tough polymer.

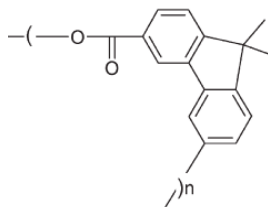

Fig. 3-9. Structure of polycarbonate

Fluoropolymers

There are only a limited number of different polymerized fluoropolymers of which poly(tetrafluoroethylene) (PTFE) and poly(vinylidene fluoride) (PVDF) are the most common in general and especially in membrane science. The chemical structures of these polymers are presented in Fig. 3-10. All have in common a very high chemical and oxidative stability, but are not stable against irradiation. The compatibility with most solvents and the thermal resistance is outstanding.

For PTFE, the very high maximum operating temperature of >260°C and a resistivity against all known solvents make it a membrane polymer of choice for the filtration of chemicals or hot air. In particular, the extreme hydrophobicity of the polymer results in an excellent air filtration membrane with superior blow down properties after steam sterilization. Another consequent application is the classical utilization as a steam permeable, but water repelling barrier. Due to its high resistance against solvents, a classical casting approach for manufacturing a membrane from this material is not possible. The only membranes of PTFE are produced by stretching the still hot extruded PTFE film until a controlled and defined “micro-tearing” of the film results in a porous PTFE membrane structure. This process is rather unique for PTFE.

PVDF has properties comparable to PTFE with respect to the resistance against abrasion, hydrophobicity and physical robustness. It also shows a high tolerance against elevated temperatures and is stable against most solvents. However, unlike PTFE, PVDF is not stable against most polar solvents. On the other hand, this fact offers the opportunity to produce cast membranes with higher porosities from this polymer material. As it is not as hydrophobic as PTFE, the applications in air filtration or as a water barrier are limited. The main utilization in filtration is sterile filtration of solvents and water based liquids. For this, the membrane has to be surface treated or grafted with a hydrophilizing agent, such as acrylic acid. This surface coating reduces the hydrophobic character of the membrane surface, but also reduces the chemical stability of the whole membrane. For example, the PVDF membrane is stable against extreme caustic conditions, while the acrylic coating starts to degrade under these conditions. The resulting membranes are mainly symmetric with high porosities, resulting in good flow rates, but limited total throughput values. Due to these parameters, the applications of PVDF are limited to certain ranges of microfiltration.



Fig. 3-10. Structure of PVDF (left) and PTFE (right)

3.2.1.2. Inorganic membranes

Inorganic membrane materials are starting to become more important. They are much more chemically and thermally stable than polymers, but have been limited in their use mainly due to the expense of the material.

The ceramic membrane can be described as an asymmetric porous material formed by macroporous support with successive thin layers deposited on it. The support provides mechanical resistance to the medium. Typically, porous ceramic membranes are asymmetric with a support thickness of about 1-3 mm. The

microfiltration layer is usually 10-30 μm thick and the most common oxides used for the membrane are zirconia (ZrO_2) and alumina (Al_2O_3). Ultrafiltration membranes are a few micrometers thick and typical materials are alumina, zirconia, titania (TiO_2) and ceria (CeO_2). Nanofiltration membranes are less than 1 μm thick and are generally made of zirconia and titania. The support and the microfiltration layer are elaborated by classical ceramic techniques, whereas the sol-gel process is used for ultra- and nanofiltration layers. The structure of ceramic membranes is presented in Fig. 3-11. Ceramic membranes have mostly been made in two geometries: tubular and flat sheet.

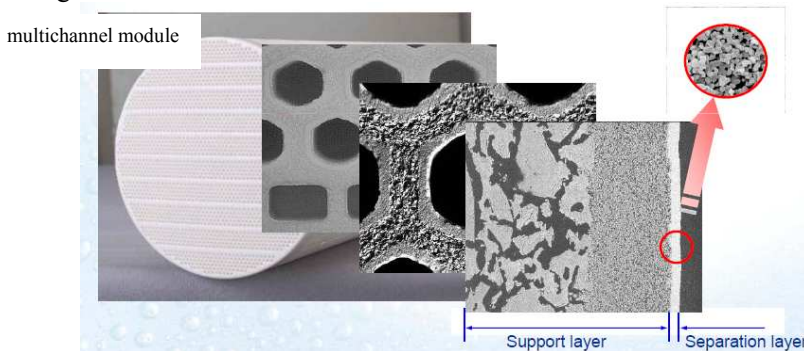

Fig. 3-11. Ceramic membrane (based on [9])

The advantages of ceramic membranes include

- narrow and well defined pore size distribution in comparison with their polymeric counterparts,
- high thermal stability,
- fine chemical stability and biocompatibility,
- good erosion resistance and non-compactability.

These properties enable ceramic membranes to be used in more severe environments than polymeric membranes and with more rigorous cleaning procedures, such as stronger cleaning agents, steam sterilization, back-flushing and ultrasonic cleaning. Moreover, ceramic membranes are less susceptible to microbial attack and biological degradation. In some cases, they also show catalytic or electrochemical activities. The disadvantage of ceramic membranes stems mainly from the manufacturing process which makes it difficult to achieve a reproducible final product quality. This, along with the intrinsically brittle character of ceramic membranes, makes them always more expensive than polymeric membrane systems. In addition, ceramic membrane modules usually have a relatively larger footprint and are much heavier compared to polymeric

membranes. However, because of their excellent properties in terms of thermal and chemical stability, ceramic membranes have many applications in the food, beverage, biotechnological and pharmaceutical industries as well as in the petrochemical industry, environmental control, electronic industry, gas separation and other process industries.

Due to the high cost of ceramic membranes (e.g., $\geq \$1,000/\text{m}^2$ compared to $\$100/\text{m}^2$ for polymeric counterparts), in the 20th century the use of inorganic membranes has been limited primarily to food, beverage and pharmaceutical industry applications [10]. As presented in Fig. 3-12, the price of organic membranes showed a sharp decrease in recent years making it possible that a similar development for ceramic membranes may occur in the future.

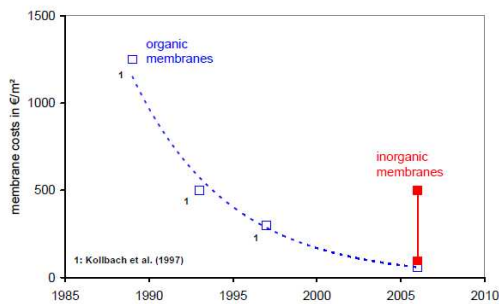

Fig. 3-12. Prices of organic and inorganic membranes (based on [10])

The advantages of organic and inorganic membranes are presented in Table 3.

Table 3. Comparison of organic and inorganic membranes

| Organic membranes | Inorganic membranes |
|-------------------------------------------------------------------------------------------------------------------------------------------------------------------------------------------------------------------------------------------------------------------------------------------------------------------------------------------------------------------------------------|--------------------------------------------------------------------------------------------------------------------------------------------------------------------------------------------------------------------------------------------------------------------------------------------------------------------------------------------------------------------------------|
| <ul style="list-style-type: none"> • inexpensive, • developed before inorganic membranes, • light, • flexible and can easily be cast or molded into various shapes and sizes • certain membrane types (e.g. hollow fibers) can only be prepared with organic polymers • a wide range of membrane chemistry is available | <ul style="list-style-type: none"> • can withstand higher transmembrane pressure • generally more durable (although ceramic and glass membranes can be quite brittle and hence susceptible to breakage) • resistant to a wider variety of chemical substances e.g. acids, alkali and solvents • can easily be cleaned and sterilized |

3.2.2. Classification according to separation mechanism

There are generally three mechanisms of separation which depend on one specific property of the components to be selectively removed or retained by the membrane:

- *sieve mechanism* – separation based on a large difference in size,
- *solution-diffusion mechanism* – separation based on the difference in solubility and diffusivity of materials in the membrane,
- *electrochemical mechanism* – separation based on the difference in the charges of the species to be separated.

3.2.3. Classification according to membrane structure and morphology

Synthetic membranes can be divided into the following groups:

- porous membranes,
- dense (nonporous) membranes,
- electrically charged barriers,
- liquid membranes.

Pores in porous membranes can be divided into [11]:

- macropores – larger than 50 nm,
- mesopores – 2-50 nm,
- micropores – smaller than 2 nm.

Membranes can be classified by their structure:

- homogenous (microporous or dense),
- heterogeneous (asymmetric or thin film composite).

The structure of homogenous membranes is uniform throughout. Homogenous microporous membranes, called symmetric membranes, have a uniform porous structure through their cross-section. The structure of a symmetric membrane is presented in Fig. 3-13.

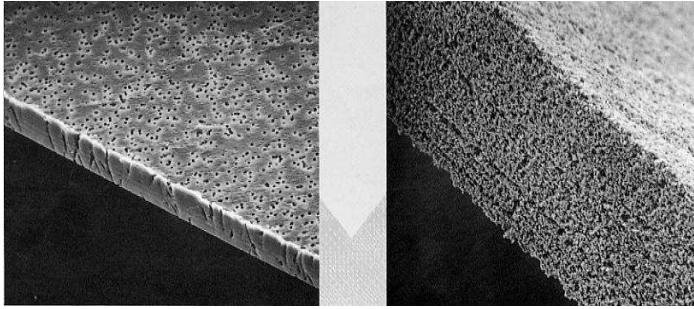

Fig. 3-13. Symmetric membranes (based on [8])

Heterogeneous membranes have non-uniform pore structures. The structure of an asymmetric membrane consists of two layers (Fig. 3-14): the top layer is very thin ($0.1-1\ \mu\text{m}$) and dense (it is also called the top skin layer) while the bottom layer is a porous sublayer ($100-200\ \mu\text{m}$). The dense top layer governs the performance (permeation properties) of the membrane with the porous sublayer only providing mechanical strength to the membrane. The membranes with a symmetric structure do not possess a top dense layer. In asymmetric membranes, when the material of the top layer and porous sublayer are the same, the membrane is called an integrally skinned asymmetric membrane. In contrast, if the polymer of the top skin layer is different from the polymer of the porous sublayer, the membrane is called a composite membrane (Fig. 3-15). The advantage of composite membranes over integrally skinned asymmetric membranes is that the material for the top skin layer and the porous sublayer can be selected separately to optimize the overall performance.

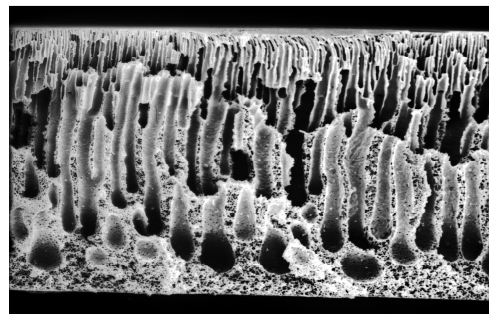
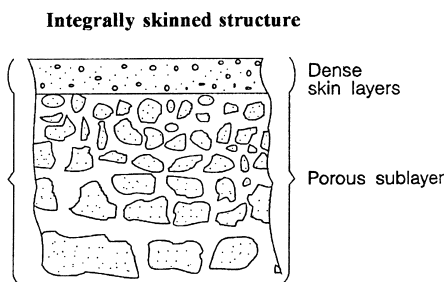

Fig. 3-14. Cross-section of an asymmetric membrane

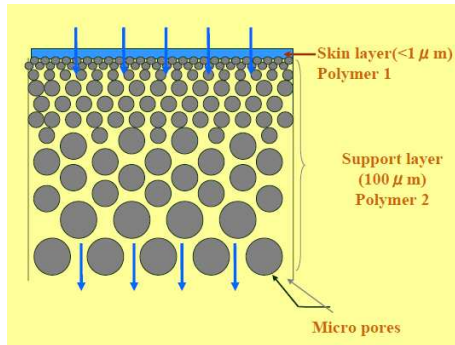

Fig. 3-15. Structure of a composite membrane (based on [12])

3.2.4. Classification according to membrane geometry

Synthetic membranes are fabricated in two main geometries:

1. Flat sheet – utilized in the construction of flat sheet, disc, spirally wound, plate and frame modules;
2. Cylindrical – utilized in tubular and capillary or hollow fiber modules.

Based on dimensional differences, the following types of cylindrical membranes may be distinguished:

- tubular membranes with an internal diameter larger than 10 mm,
- capillary membranes with an internal diameter 0.5-10 mm,
- hollow-fiber membranes with a diameter smaller than 0.5 mm.

4. MEMBRANE PREPARATION

Membranes can be manufactured using one of several methods. Membrane manufacturing techniques include, but are not limited to, phase inversion, membrane stretching, sintering and track-etching. Of these, phase inversion is the most common.

4.1. Phase inversion technique

The majority of available asymmetric or asymmetric-based composite membranes are prepared by the so-called phase inversion process. With this method the membrane is formed by the creation of two phases. One phase has a high concentration of the chosen polymer, a low concentration of solvents and forms a solid. The other phase remains a liquid, has a lower concentration of polymer, a higher concentration of solvents and forms the pores of the membrane. The polymer-rich phase can be precipitated using solvent evaporation, polymer cooling, absorption of a non-solvent (e.g. water) from the vapor phase and by precipitation in a non-solvent.

Among the methods used to achieve phase inversion, the dry-wet phase inversion technique and thermally induced phase separation (TIPS) are the most common in membrane manufacturing. The dry-wet phase inversion technique, also called the Loeb-Sourirajan technique, was used by Loeb and Sourirajan in developing the first cellulose acetate membrane for seawater desalination. In this method, a polymer solution is prepared by mixing polymer and solvent (sometimes even nonsolvent). The solution is then cast on a suitable surface by a doctor blade to a precalculated thickness. After the partial evaporation of the solvent, the cast film is immersed in a nonsolvent medium called a gelation bath (Fig. 4-1). Due to the sequence of two desolvation steps, i.e. evaporation of the solvent and solvent-nonsolvent exchange in the gelation bath, solidification of the polymer film takes place. It is desirable to choose a solvent with a strong dissolving power and a high volatility. During the first step of desolvation by solvent evaporation, a thin skin layer of solid polymer is instantly formed on top of the cast film due to the loss of solvent. In the solvent-nonsolvent exchange process that follows, the nonsolvent diffuses into the polymer solution film through the thin solid layer while the solvent diffuses out. The top skin layer can also be made porous by lowering the polymer concentration in the casting solution as well as reducing the solvent evaporation period.

As presented in Fig. 4-2, the phase inversion technique can be used in the production of flat or tubular membranes. Nearly all reverse osmosis, ultrafiltration,

microfiltration and many gas separation membranes are manufactured using phase inversion.

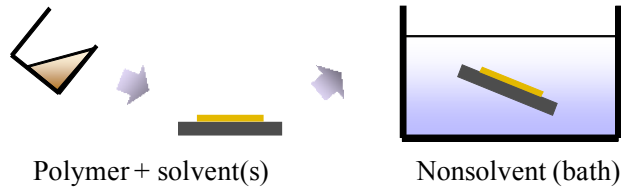

Fig. 4-1. Phase inversion process

The structure and properties of membranes formed by the phase inversion process depends on the

- nature of the polymer,
- nature of the solvent and nonsolvent,
- composition of the casting solution,
- composition of the coagulation bath,
- gelation and crystallization behavior of the polymer.

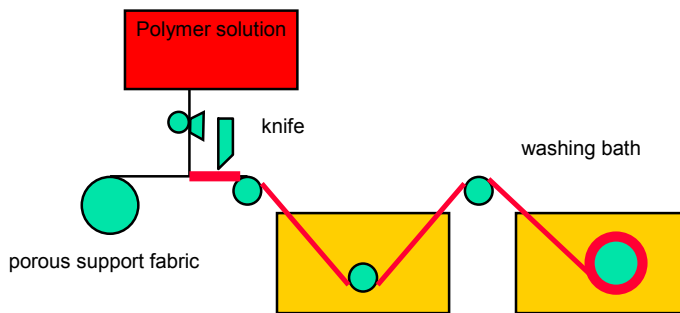

Fig. 4-2. Production of flat membranes using the phase inversion process

4.2. Track-etching

Microporous membranes with very uniform, nearly perfectly round pores are obtained by the track-etching process originally developed by the Nucleopore Corporation. These membranes are made in two steps. First, a sheet of polymeric film (10-15 μm thick), usually polycarbonate or a cellulosic ester, is placed underneath a radiation source and is irradiated by high-energy particles. The

locations subjected to particle bombardment are degraded or chemically altered during this process. In the second step, the film undergoes an etching process in an alkaline or hydrogen peroxide bath (depending on the material) where the polymer is etched along the path of high-energy particles. The pore density of track-etched membranes depends on the residence time in the irradiator, while the pore diameter is controlled by the residence time in the etching bath [13]. The minimum pore diameter of these membranes is approximately $0.01\ \mu\text{m}$ [14]. Membranes made by track-etching have the disadvantage of a relatively low overall porosity (about 15% maximum) limiting the throughput.

The basic concept of track-etching membrane production is depicted in Fig. 4-3.

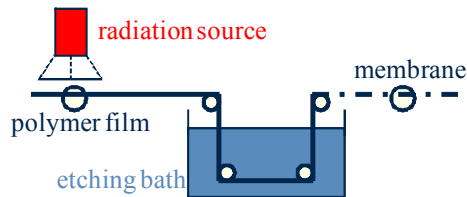

Fig. 4-3. Track-etching membrane production

4.3. Stretching

Stretching is another method used to produce porous symmetric membranes from homopolymers. The most common polymers formed with membrane stretching are PTFE, polypropylene, and polyethylene. In this process, a crystalline or partially crystalline polymer is heated nearly to its melting point and extruded while being drawn down rapidly. This causes the polymer chains to become aligned or “oriented”. The polymer is then stretched rapidly at a 90° angle to the original extrusion. This causes long, narrow slits to form which can be controlled to a specific nominal pore size. Overall pore distribution is much more regular than with irradiation meaning that greater porosities are possible without increasing the variation in pore diameter. At low porosities, however, pores produced by stretching exhibit a higher level of variability than capillary pores. The porosity of these membranes is very high and values up to 90% can be obtained. Membrane stretching is used to make porous membranes of which Gore-Tex, made from PTFE by W.L. Gore, is the most common [15].

4.4. Sintering

This method involves compressing a powder consisting of particles of a given size and sintering at a temperature just below the melting point of the polymer. The required temperature for sintering depends on the material used. This process yields a microporous structure of relatively low porosity in the range of 10-40 % and a rather irregular pore structure with a very large pore size distribution. The particle size of the powder is the main parameter determining the pore size of the membrane, which can be made in the form of discs, candles, or fine-bore tubes. This type of membrane is widely used for the separation of radioactive isotopes, especially uranium.

5. BASIC PARAMETERS OF MEMBRANE PROCESSES

5.1. Membrane characterization

Membrane processes are used to solve a wide range of separation problems and for this reason membranes of significantly different properties must be used. As presented in Fig. 5-1, membrane properties influence their transport and separation parameters.

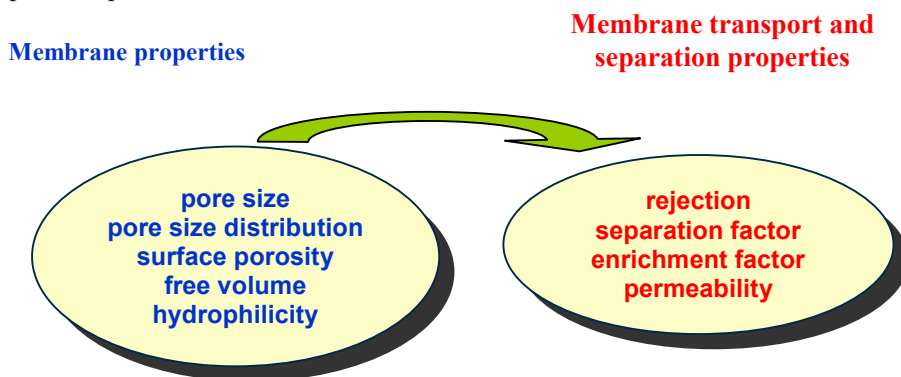

Fig. 5-1. Membrane properties in relation to membrane process efficiency

To precisely characterize membranes, the following elements should be analyzed:

1. mechanical properties,
2. chemical resistance and compatibility,
3. hydraulic permeability,

4. average porosity and pore size distribution,
5. sieving properties,
6. material hydrophilicity,
7. electrical properties.

The evaluation of mechanical properties should include determination of:

- tensile strength,
- elastic properties,
- flexibility,
- ease of cutting,
- integrity and bursting pressure,
- interaction with support,
- sealing requirements,
- resistance to wear and tear.

When describing chemical resistance and compatibility, the following elements should be taken into account:

- operating pH range,
- compatibility with solutes,
- binding of solutes,
- compatibility with solvents,
- compatibility with adhesives,
- compatibility with cleaning agents.

Hydraulic permeability of a membrane depends among others on its porosity, pore size and membrane thickness. Higher hydraulic permeability means higher productivity of the process. These properties are determined by filtering pre-filtered deionized water at different transmembrane pressures and are presented as shown in Fig. 5-2.

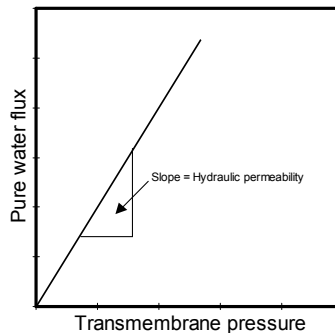

Fig. 5-2. Presentation of membrane hydraulic permeability

For porous membranes, it is very important to describe their porosity and pore size distribution. Among others, the following parameters should be considered:

- the shape of the pore or its geometry,
- pore size distribution,
- surface porosity.

In the majority of membranes the pores do not have the same size, but exist as a distribution of sizes (Fig. 5-3). The separation characteristics are determined by the large pores in the membrane.

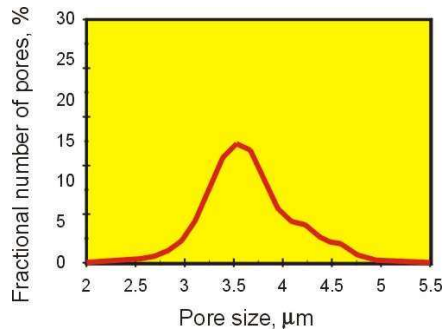

Fig. 5-3. Pore size distribution in a microfiltration membrane

Surface porosity is a very important factor in determining the hydraulic permeability of membranes. It can be calculated from the equation

$$\varepsilon = n_p \cdot \frac{\pi \cdot r^2}{A_m} \quad (5-1)$$

where r – the pore radius, n_p – number of pores and A_m – membrane area. Microfiltration membrane surface porosity amounts to 5-70% while for ultrafiltration membranes it ranges from 0.1 to 1% [16].

Membrane porosity and pore size distribution significantly influence the membrane cut-off, one of the most important parameters describing porous membranes. Molecular weight cut-off (MWCO) is a number expressed in Dalton indicating that 90% of the species with a molecular weight larger than the MWCO will be rejected (Fig. 5-4).

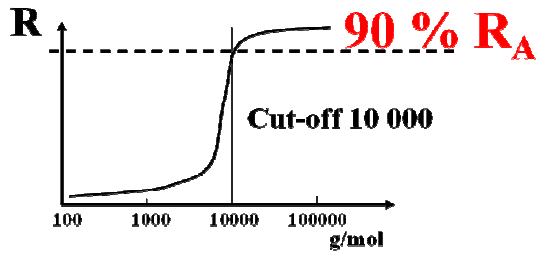

Fig. 5-4. Molecular weight cut-off determination

Depending on the chemical nature of the material that the membrane is made of, it may be hydrophilic or hydrophobic. Polyethylene, polypropylene and polytetrafluoroethylene are examples of hydrophobic polymers. Hydrophilic polymers include cellulose materials, polyethersulfone and nylon 6,6. Ceramic and sintered metal membranes are generally hydrophilic.

Hydrophilic membranes are easily wetted by a polar solvent such as water. Hydrophobic membranes are wetted by nonpolar solvents such as hexane. Aqueous solutions should be filtered with the use of hydrophilic membranes, while gases are generally filtered with hydrophobic membranes.

The hydrophilicity of a surface is expressed in terms of the water contact angle (Θ) measured as presented in Fig. 5-5. Hydrophilic surfaces have contact angles close to 0° , while more hydrophobic materials exhibit contact angles close to or above 90° .



Fig. 5-5. Contact angle measurement (based on [17])

Hydrophilic/hydrophobic material properties influence membrane susceptibility to fouling. The tendency of hydrophobic membrane blocking is significantly higher compared to hydrophilic membranes.

5.2. Evaluation of membrane performance

The performance or efficiency of a given membrane is determined by two parameters:

- selectivity,
- flow through the membrane.

The selectivity of a membrane towards a mixture is generally expressed by one of two parameters: the retention coefficient (R) or the separation factor (α).

For dilute aqueous mixtures consisting of a solvent and a solute, it is more convenient to express selectivity in terms of the retention (R) towards the solute.

The retention coefficient is given by

$$R = (c_0 - c_p) / c_0 \cdot 100, \% \quad (5-2)$$

where c_0 is the solute concentration in the feed and c_p is the solute concentration in the permeate. The value of R varies between 100%, when an “ideal membrane” completely retains the solute, and 0% when solute and solvent pass through the membrane freely.

Membrane selectivity towards gas mixtures and mixtures of organic liquids is usually expressed in terms of a separation factor α . For a mixture consisting of components A and B the selectivity factor $\alpha_{A/B}$ is given by

$$\alpha_{A/B} = y_A / y_B / x_A / x_B \quad (5-3)$$

where y_A and y_B are the concentrations of components A and B in the permeate and x_A and x_B are the concentrations of the components in the feed. The selectivity α is chosen in such a way that its value is greater than 1. Thus, if the permeation rate of component A through the membrane is larger than that of component B, the separation factor is denoted as $\alpha_{A/B}$; if component B permeates preferentially, the separation factor is given by $\alpha_{B/A}$. In the case that $\alpha_{A/B} = \alpha_{B/A} = 1$, no separation is achieved.

The hydraulic efficiency of membrane processes is often denoted as permeate flux J, expressed as

$$J = Q / A \cdot t \quad (5-4)$$

where Q is the volume of permeate collected during time t while A is the membrane surface.

Permeate flux is the volume/mass or number of moles of a specified component passing per unit time through the unit of membrane surface area.

In the case of pressure driven membrane processes, membrane hydraulic efficiency may also be expressed in terms of hydraulic permeability L, given by

$$L=J/\Delta p \quad (5-5)$$

where Δp is the transmembrane pressure.

The efficiency of membrane separation processes is also analyzed in terms of the recovery factor Y , calculated from the equation

$$Y=Q_p/Q_f \quad (5-6)$$

where Q_f is the flow of feed and Q_p is the flow of permeate.

The value of the actual pressure working as a driving force depends significantly on solution osmotic pressure. Osmotic pressure (π) is the hydrostatic pressure produced by a solution in a space divided by a semipermeable membrane due to a differential in the concentrations of solute. The solution osmotic pressure can be calculated from the following equation:

$$\pi = c \cdot R \cdot T \quad (5-7)$$

where c – molar concentration, R – gas constant and T – temperature.

The values of osmotic pressure for several substances are given in Table 4.

Table 4. Osmotic pressure at 25°C

| Substance | Concentration | | Osmotic pressure, MPa |
|---------------------------------|---------------|---------|-----------------------|
| | mg/l | mol/l | |
| NaCl ($M_w=57.5$) | 35000 | 0.6 | 2.708 |
| NaCl ($M_w=57.5$) | 1000 | 0.0171 | 0.078 |
| NaHCO ₃ ($M_w=84$) | 1000 | 0.0119 | 0.087 |
| CaCl ₂ ($M_w=111$) | 1000 | 0.0008 | 0.056 |
| Saccharose ($M_w=342$) | 1000 | 0.00292 | 0.007 |
| Glucose ($M_w=180$) | 1000 | 0.00555 | 0.014 |

For pressure driven membrane processes it is very important to determine precisely the value of the driving force, i.e. working pressure Δp_w , calculated as

$$\Delta p_w = \Delta p_{tm} - \Delta \pi_{tm} \quad (5-8)$$

where Δp_{tm} is the transmembrane pressure and $\Delta \pi_{tm}$ is the transmembrane osmotic pressure.

Transmembrane pressure Δp_{tm} is calculated as

$$\Delta p_{tm} = (p_f + p_c) / 2 - p_p \quad (5-9)$$

where p_f is the feed pressure, p_c is the concentrate pressure, and p_p is the permeate pressure.

Transmembrane osmotic pressure $\Delta \pi_{tm}$ is calculated as

$$\Delta \pi_{tm} = (\pi_f + \pi_c) / 2 - \pi_p \quad (5-10)$$

where π_f and π_c are respectively the feed and concentrate osmotic pressures while π_p is the permeate osmotic pressure.

6. CHARACTERISTICS OF MEMBRANE PROCESSES

A wide variety of membrane processes can be categorized according to driving force, membrane type and configuration, or removal capabilities and mechanisms.

Transport of selected species through the membrane is achieved by applying a driving force across the membrane. The driving forces are either

- pressure,
- temperature,
- concentration,
- electrical potential.

6.1. Pressure driven membrane processes

Pressure driven membrane processes are often classified by pore size into four categories:

- microfiltration (MF),
- ultrafiltration (UF),
- nanofiltration (NF),
- reverse osmosis (RO).

Although the driving force in all pressure driven techniques is the same, due to different membrane properties each process is able to remove different components from the feed stream (Fig. 6-1).

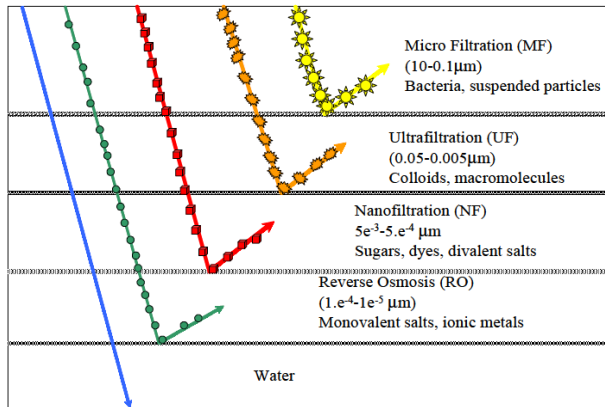

Fig. 6-1. Separation potentiality of pressure driven membrane processes

According to The Freedonia Group Report [18], pressure driven membrane processes account for the largest share of the total membrane market (Fig. 6-2).

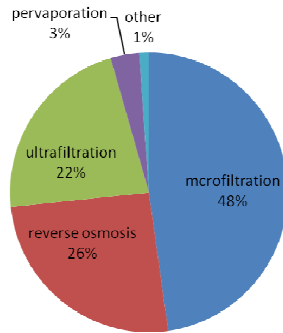

Fig. 6-2. US membrane demand in 2009 (based on [18])

Approximate pore size and generally applied pressures together with some typical applications are given in Table 5.

Table 5. Some data of pressure driven membrane processes

| | Pore size, μm | Applied pressure, MPa | Typical applications |
|-----------------|--------------------------|-----------------------|----------------------------------------------------------------------|
| Microfiltration | 0.05 - 10 | 0.01 - 0.2 | separation of colloids and particles |
| Ultrafiltration | 0.002 - 0.05 | 0.1 - 1 | separation of macromolecules |
| Nanofiltration | 0.001 - 0.002 | 0.5 - 2 | separation of divalent ions and substances of MW < 200 Da MW solutes |
| Reverse osmosis | < 0.001 | 1 - 10 | separation of ions |

The separation spectrum of pressure-driven membrane processes is illustrated in Figs. 6-3 and 6-4, while Fig. 6-5 presents average fluxes of filtration membranes.

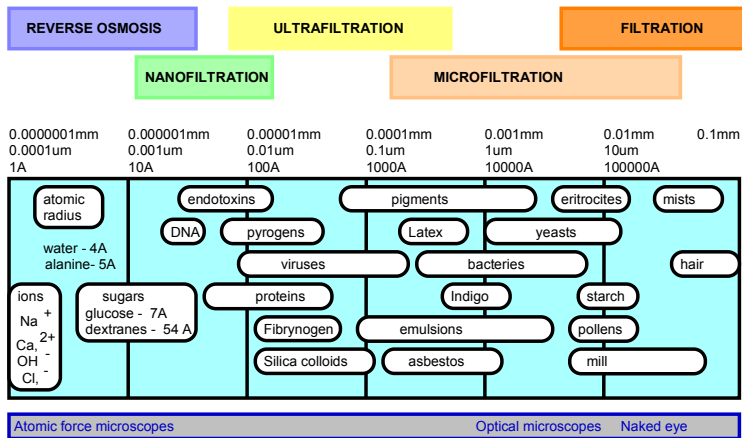

Fig. 6-3. The filtration spectrum

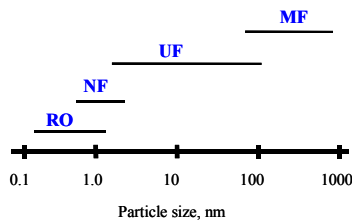

Fig. 6-4. Pore sizes of various membranes

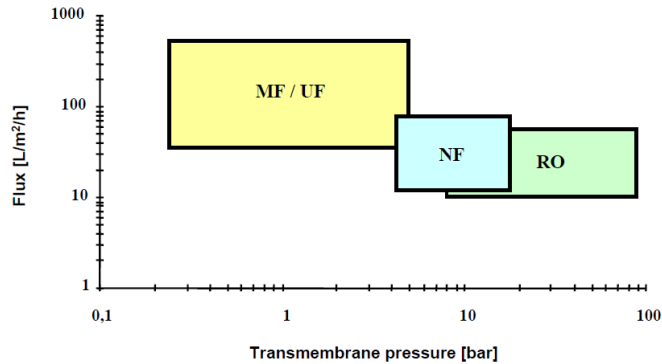

Fig. 6-5. Average membrane permeability of pressure-driven membrane processes (based on [19])

The selection of the process is very complex and depends among others on

- treatment goal,
- composition of the feed stream,
- financial constraints,
- local conditions.

Fig. 6-6 presents an example of a membrane process selection chart.

6.1.1. Microfiltration

Microfiltration is defined as a membrane separation process using membranes with a pore size of approximately 0.05 to 10 μm , a MWCO of greater than 100,000 Da and a relatively low feedwater operating pressure of approximately 0.01 to 0.2 MPa. Representative materials removed by MF include sand, silt, clays, *Giardia lamblia* and *Cryptosporidium* cysts, algae, and some bacterial species (Fig. 6-3). MF is not an absolute barrier to viruses; however, when used in combination with disinfection, MF appears to control these microorganisms in water.

Microfiltration membranes have a symmetric structure and are made from different materials such as polymers, ceramics, glass, metal and silicon. They are manufactured with different techniques: phase-inversion (e.g. diffusion induced phase separation from vapor or liquid or thermally induced phase separation), track-etching, sintering (ceramic membranes), spinodal decomposition (glass membranes), electro-deposition (metal membranes) or photolithographic etching (microsieves).

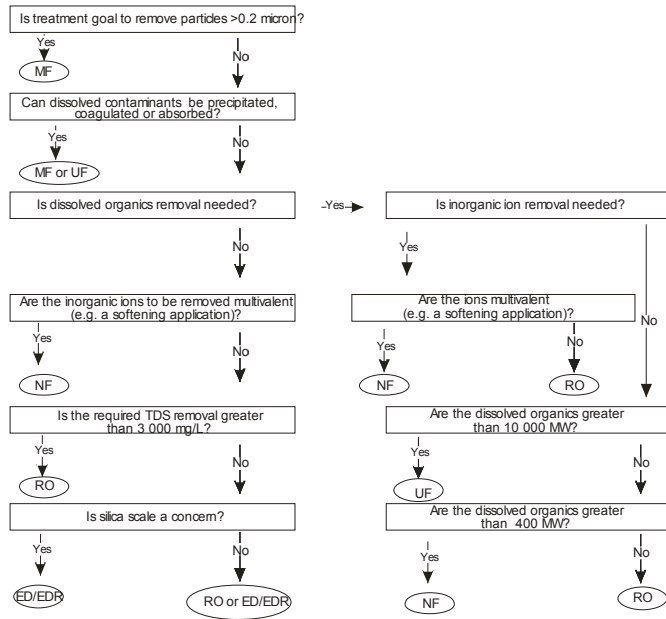

Fig. 6-6. Generalized membrane process selection chart (MF-microfiltration, UF-ultrafiltration, NF-nanofiltration, RO-reverse osmosis, ED-electrodialysis, EDR – reversal electrodialysis) (based on [20])

MF membranes use a sieving mechanism for retaining particles larger in size than the pore diameter.

The primary impetus for the more widespread use of MF has been the increasingly stringent requirements for removing particles and microorganisms from drinking water supplies. Additionally, there is a growing emphasis on limiting the concentrations and number of chemicals that are applied during water treatment. By physically removing pathogens, membrane filtration can significantly reduce chemical addition such as chlorination. Another application for the technology is for the removal of natural or synthetic organic matter to reduce fouling potential. In its normal operation, MF removes little or no organic matter; however, when pretreatment is applied, increased removal of organic material as well as a reduction in membrane fouling can be achieved. Two other applications involve using MF as a pretreatment step for RO or NF to reduce fouling potential. Both RO and NF have been traditionally employed to desalt or remove hardness from groundwater.

Apart from applications in the water treatment sector MF is also used in

- cutting oil emulsion treatment,
- juice, wine and beer clarification,
- fermentation product separation,
- recovery of precipitated metals.

6.1.2. Ultrafiltration

Ultrafiltration involves the pressure-driven separation of materials from water using a membrane pore size of approximately 0.002 to 0.1 μm , an MWCO of approximately 1,000 to 100,000 Da and an operating pressure of approximately 0.1 to 1 MPa. Table 6 presents the relation between UF membrane cut-off and pore size.

Table 6. UF membrane cut-off versus pore size

| Cut-off, Da | Pore diameter, nm |
|-------------|-------------------|
| 1,000,000 | 100 |
| 500,000 | 20 |
| 100,000 | 10 |
| 50,000 | 4 |
| 10,000 | 2.5 |
| 5,000 | 1.5 |

UF removes all microbiological species removed by MF as well as some viruses (but it is not an absolute barrier to viruses) and humic materials (Fig. 6-3). UF membranes are capable of retaining species in the range of 300-500,000 Da of molecular weight [21]. Typical rejected species include sugars, bio-molecules, polymers and colloidal particles. The primary mechanism is size exclusion, but chemical interactions between solute and membrane as well as operating parameters can affect the process.

Ultrafiltration membranes are anisotropic with a “skin” layer fused on top of a microporous support. The skin layer provides selectivity to the membrane while the role of the microporous backing layer is to provide mechanical support. The thickness of the skin layer can range from 0.2 to 10 μm depending on the material and the application.

Ultrafiltration membranes can be made from both organic (polymer) and inorganic materials. Among organic materials, the most popular are polysulfone, polyethersulfone, sulfonated polysulfone, polyvinylidene fluoride, polyacrylonitrile, cellulose, polyimide, polyetherimide, aliphatic polyamides, and polyetherketone.

Ultrafiltration is often used in the water and wastewater sector as well as in industry for

- colloid separation,
- COD reduction in wastewater,
- metal finishing water treatment,
- treatment of black-liquor from paper pulping,
- protein recovery from blood plasma,
- egg white concentration,
- serum recovery from milk.

According to [22], the largest application of MF and UF installations is for drinking water followed by wastewater (which is a rapidly growing segment) (Fig. 6-7). The 1993 *cryptosporidiosis* outbreak in Milwaukee, Wisconsin, where 403,000 citizens were affected, and the Clark County outbreak were major reasons for the rapid growth of MF and UF membrane application in the water treatment sector (Fig. 6-8).

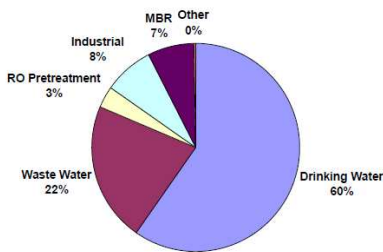

Fig. 6-7. Global applications of low-pressure membranes (based on [22])

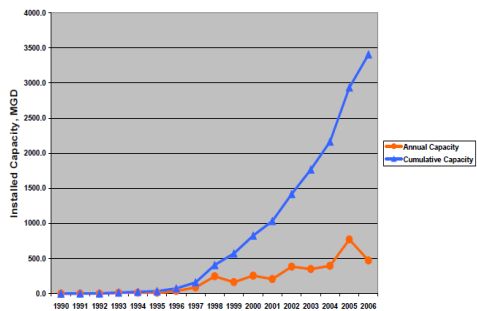

Fig. 6-8. Global installed capacity of low-pressure membranes (based on [22])

When analyzing geographical distribution of low-pressure membrane systems (Fig. 6-9) one can see that the US market plays a dominant role.

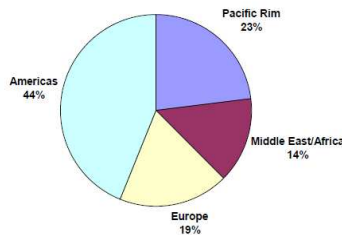

Fig. 6-9. Regional distribution of low-pressure membranes (by volume) (based on [22])

However, ultrafiltration applications are not only limited to the water and wastewater sector. As presented in Table 7, this process is also utilized in several other sectors.

Table 7. Standard applications for ultrafiltration

| Sector | UF application | Objectives |
|----------------------------------|------------------------------------------------|-----------------------------------------------------------------------------|
| Desalination | water pretreatment (i.e. upstream NF/RO units) | biofouling and organic fouling prevention, silica removal |
| Chemicals & wastewater | electrophoretic paint | recycle paint to dip-tank and water reuse |
| Fuels and chemicals & wastewater | oil/water emulsions | lubricant concentration and reuse |
| Food and beverage | wine/juice/beer clarification | haze component removal from wine, beer or juice |
| | cheese whey | concentration and fractionation of proteins from lactose and dairy products |
| Biopharmaceuticals | medical drugs, vaccines | undesirable contaminant removal, protein separation |
| Biotechnology | protein fractionation, diagnostics | concentration and fractionation of biomolecules for lab applications |

6.1.3. Nanofiltration

Nanofiltration is a liquid separation membrane technology positioned between reverse osmosis and ultrafiltration. NF refers to a membrane process that rejects solutes approximately 1 nm in size with a molecular weight above 200 Da. Nanofiltration is a lower-pressure version of RO and is used where the high rejection of salts is not necessary. NF is capable of removing bacteria and viruses as well as organics related to water color. It is also used to remove pesticides and other organic contaminants from surface and ground water.

NF membranes reject multivalent ions to a significantly greater degree than monovalent ions. The specific rejection of ions varies from one membrane manufacturer to another, but a multivalent ion rejection of 95 % with a monovalent ion rejection of only 20 % might be observed.

In the water treatment sector NF is referred to as “membrane softening”, as it is an attractive alternative to chemical softening.

Nanofiltration membranes are usually charged (carboxylic groups, sulfonic groups, etc.) and as a result ion repulsion (Donnan exclusion) is the factor

determining salt rejection. In practical terms this means that more highly charged ions such as SO_4^{2-} have higher rejection rates by a negatively-charged nanofiltration membrane than monovalent ions such as Cl^- . Because the dimensions of the pores are less than one order of magnitude larger than the size of ions, charge interaction plays a dominant role. These membranes also usually have good rejection rates for organic compounds with molecular weights above 200 to 500 Da.

Nanofiltration (NF) membranes are generally classified into two major groups: organic polymeric and inorganic ceramic membranes. Polymeric membranes constitute the most important group and have been commercially available for many years; however, currently several inorganic membranes made of TiO_2 and ZrO_2 are available.

The most important application areas of NF are as follows:

- removal of monovalent ions from wastewater, reaction mixtures in which NaCl is formed and whey,
- separation of ions with different valences,
- separation of low- and high-molecular weight components.

6.1.4. Reverse osmosis

Reverse osmosis, simply stated, is the opposite of the natural osmosis phenomenon. Osmosis is a natural process that moves water across a semipermeable membrane from an area of greater concentration to an area of lesser concentration until the concentrations are equal. Osmosis refers to the transfer of solvent but not of the solute through a membrane. The idea of natural osmosis is presented in Fig. 6-10. Initially, two solutes at different concentrations are separated by a semipermeable membrane that allows transport of only solvent and not of solute. The solute concentration C_1 is larger than the C_2 . As time passes, solvent flows through the membrane from the lower solute concentration to the higher concentrated solution. In this respect, the solvent acts to dilute the more concentrated solute. This solvent flow is called osmosis. Because of osmosis, the liquid level on the concentrated solute side increases yielding a hydrostatic pressure difference. This flow continues until the equilibrium is reached. The hydrostatic pressure difference between the two solutions at equilibrium is called the osmotic pressure.

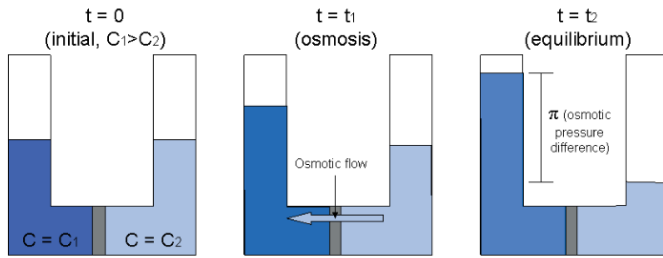

Fig. 6-10. Osmosis and osmotic pressure (based on [23])

When a pressure higher than the osmotic pressure is mechanically applied to the concentrated solution, pure water will flow through the membrane to the diluted solution while dissolved salts and impurities are left behind. This method is called reverse osmosis (it has also been referred to as hyperfiltration). The principle of reverse osmosis is depicted in Fig. 6-11.

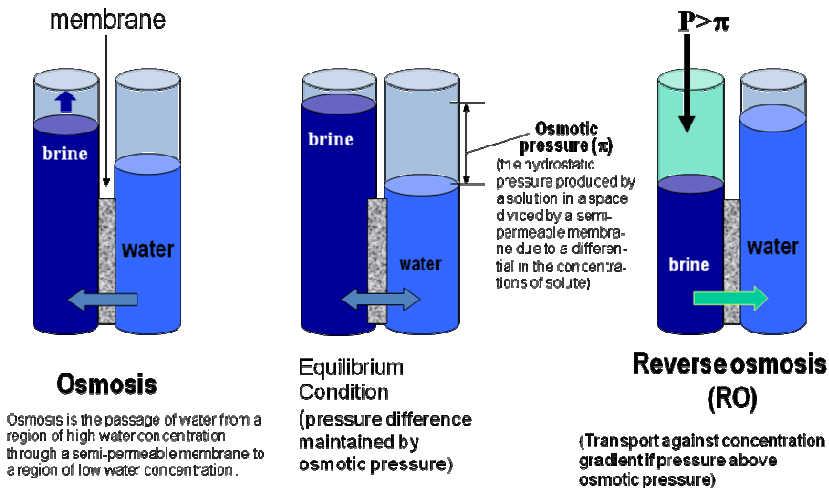

Fig. 6-11. The reverse osmosis process

In the RO process, the membrane acts as a semipermeable barrier to flow allowing selective passage of a particular species (solvent, usually water) while partially or completely retaining other species (solutes). Reverse osmosis membrane separation is primarily governed by the properties of the membrane used in the process. Most currently available RO membranes fall into one of two categories: asymmetric membranes containing one polymer and thin-film, composite membranes consisting of two or more polymer layers. Although RO

membranes have been formed and tested with a wide range of different materials and preparation techniques, the cellulosic polymers (cellulose acetate, cellulose triacetate, etc.), linear and cross-linked aromatic polyamide, and aryl-alkyl polyetherurea are among the most important RO membrane materials.

In reverse osmosis non-porous membranes or membranes of a pore size <1 nm are applied. Due to such membrane properties, transport and separation is governed by solution-diffusion and preferential sorption mechanisms. Transmembrane pressure in RO systems is high, amounting to 1.5-8 MPa due to the high osmotic pressure of treated solutions.

Reverse osmosis is mainly used in dissolved ion removal from water solutions. As presented in Fig. 6-12, this process allows the almost complete removal of inorganic ions as well as low molecular weight organic substances.

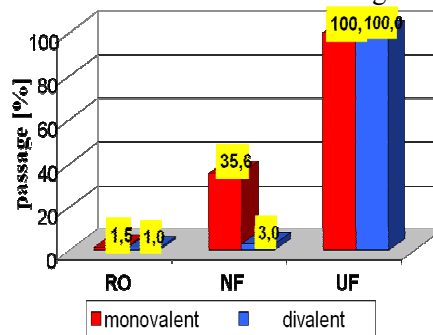

Fig. 6-12. Ion separation in pressure driven membrane processes (based on [24])

Reverse osmosis is used in

- desalination of sea and brackish water,
- hazardous waste treatment,
- metal industry (electroplating, finishing),
- landfill leachate treatment,
- ultrapure water production for the electronic industry.

A major consumer of RO membranes is the water desalination sector. Worldwide desalination capacity will reach 126 million cubic meters per day by 2016, up from 76 million in 2010 [25].

6.2. Chemical potential driven membrane processes

In many processes, including those in nature, transport proceeds via diffusion rather than convection. Substances diffuse spontaneously from the side with a high chemical potential to where the chemical potential is lower. Processes which make use of a concentration difference as a driving force include

- dialysis,
- gas/vapor separation,
- pervaporation,
- liquid membranes processes.

In dialysis, gas separation and pervaporation solid nonporous membranes made of organic or inorganic materials are used.

6.2.1. Dialysis

Dialysis is a process for selectively removing low molecular weight solutes from solution by allowing them to diffuse into a region of lower concentration through thin nonporous membranes. There is little or no pressure difference across the membrane and the flux of each solute is proportional to the concentration difference. Solute of high molecular weight are mostly retained in the feed solution because their diffusivity is low. When analyzing Fig. 6-13, one can see that solute A passes through the pores of the membrane down the concentration gradient while solute B either cannot pass or its transport is greatly restricted. In the meantime, due to the natural osmosis phenomenon, solvent transport to the dialysate down the concentration gradient occurs. Unfavorable solvent transport may be limited by an increase in the feed pressure above the osmotic pressure.

Membranes used in dialysis are made of hydrophilic polymers such as cellulose, cellulose acetate, ethylene-vinyl alcohol or polysulfone.

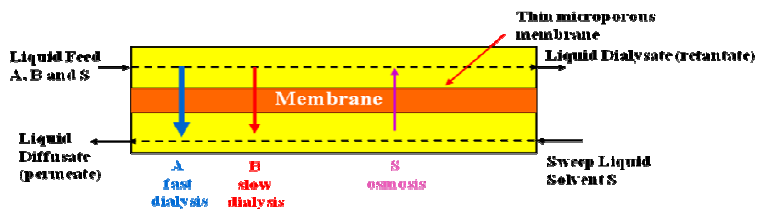

Fig. 6-13. The principle of dialysis

Nowadays, the most frequently worldwide dialysis process is used in hemodialysis or kidney dialysis where a membrane allows the passage of low molecular weight impurities such as urea from the blood stream of a patient with end-stage renal disease (Fig. 6-13). Larger compounds such as proteins and blood cells cannot pass across the dialysis membrane and are retained by the patient. The dialysis membranes help manage the fluid balance in the body and can be used to supply nutrients to patients. Currently, dialysis stations for treating patients with kidney function disorders are the biggest recipients of membranes and membrane

systems in the world. Presently throughout the world approximately 1.5 million people have been diagnosed with strong kidney failure, a disease requiring blood purification using dialysis. The number of those affected has doubled in the last 15 years and in the United States alone in 2010 approximately 600,000 patients required therapy from the application of kidney machine systems with their treatment costing nearly \$28 billion [26]. In 2007, over 180 million dialyzers for artificial kidney systems were produced compared to less than 10 million modules used in water treatment [27]. About 60% of dialyzers were made of polysulfone and 20-25 % of cellulose materials [28].

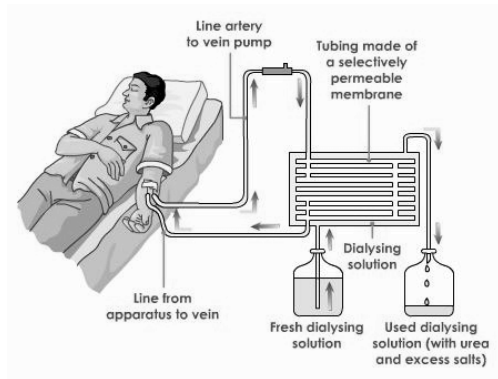

Fig. 6-14. Artificial kidney system

Apart from medical applications dialysis is also used in

- recovery of NaOH in rayon processing,
- separation of nickel sulfate from sulfuric acid in electrolytic copper refining,
- dealcoholization of beverages.

6.2.2. Gas or vapor permeation

Gas or vapor mixtures can be effectively separated by synthetic organic or inorganic membranes. Usually nonporous polymeric membranes are used and vapors and gases are separated due to their different solubility and diffusivity in polymers. Polymers in a glassy state are generally more effective for separation and predominantly differentiate in terms of diffusivity. Small molecules of penetrants move among polymer chains according to the formation of local gaps by the thermal motion of polymer segments. Free volume of the polymer, its distribution and local changes of distribution are of the utmost importance with the diffusivity of a penetrant depending mainly on its molecular size.

Porous membranes can also be utilized for gas or vapor separation. The pore diameter must be smaller than the mean free path of gas molecules. Under normal conditions (100 kPa, 300 K) this diameter is about 50 nm [29]. In this case the gas flux through the pore is proportional to the molecule velocity, i.e. inversely proportional to the square root of the molecule mass. This is known as Knudsen diffusion. Gas flux through a porous membrane is much higher than through a nonporous membrane by 3 to 5 orders of magnitude. Separation efficiency is moderate – hydrogen passes 4 times faster than oxygen.

Due to specific requirements for gas and vapor separation membranes, glassy or rubbery polymers are used. Some of these polymers are presented in Table 8. Almost all industrial membrane gas separation processes utilize glassy polymers because of their high gas selectivity and good mechanical properties. Usually with glassy polymers the more permeable species are those with a low molecular diameter while selectivity is due to differences in molecular size.

Table 8. The most important glassy and rubbery polymers used in industrial membrane gas separation [30]

| rubbery polymers | glassy polymers |
|--------------------------------------------------------------------------------|--------------------------------------------------------------------------------------------------------------------|
| poly(dimethylsiloxane) ethylene oxide/propylene oxide – amide copolymers | cellulose acetate polyperfluorodioxoles polycarbonates polyimides poly(phenylene oxide) polysulfone |

When analyzing the principle of the gas separation process (Fig. 6-15) it can be stated that molecule A passes through the membrane down the concentration gradient while the permeation of molecule B is restricted or not allowed. The real separation efficiency of the process also depends on the pressure ratio across the membrane. The driving force can be established either by applying a high pressure to the feed side or maintaining a partial vacuum on the permeate side. Gas separation processes operate with pressure differences of 0.1-2.0 MPa.

Both gas separation and vapor permeation membrane processes are mostly based on the same mechanism: sorption of the permeate into the membrane, permeation by diffusion through the membrane, desorption at the low pressure side of the membrane.

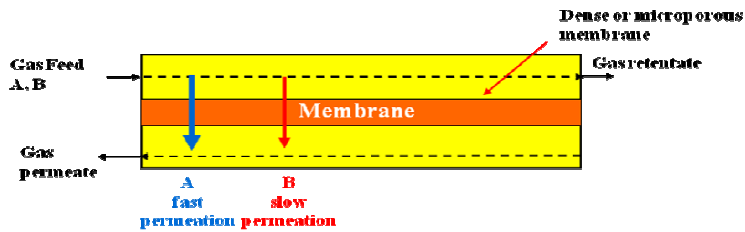

Fig. 6-15. Schematic drawing of the gas separation process

The gas separation properties of membranes depend on

- the material (permeability, separation factors),
- the membrane structure and thickness,
- the membrane configuration (e.g. flat, hollow fiber),
- the module and system design.

Membranes can be used for the

- separation of hydrogen from gases such as nitrogen and methane,
- recovery of hydrogen from product streams of ammonia plants,
- recovery of hydrogen in oil refinery processes,
- separation of methane from biogas,
- enrichment of air by oxygen for medical or metallurgical purposes,
- removal of water vapor from natural gas,
- removal of CO₂ from natural gas,
- removal of H₂S from natural gas,
- removal of volatile organic liquids from the air of exhaust streams,
- desiccation.

Membrane systems are also applied in removing volatile organic compounds, e.g. gasoline vapors in a refinery or at gasoline stations. In this way fuel losses are limited and additionally atmospheric pollution is eliminated. Many gasoline stations use vacuum-assisted dispensing systems to control the release of hydrocarbon vapors to the atmosphere. Typical systems contain up to 2 m² of membrane and cost from \$5000 to \$15,000 [28]. The idea of the system is shown in Fig. 6-16.

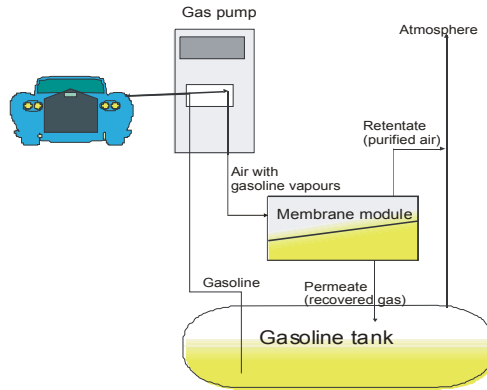

Fig. 6-16. Membrane based gasoline recovery system

6.2.3. Pervaporation

Pervaporation is the separation process in which a liquid mixture is separated by partial vaporization through a dense non-porous membrane. During pervaporation, the feed mixture is in direct contact with one side of the liophilic membrane whereas the permeate is removed in a vapor state from the opposite side into a vacuum or sweeping gas and is then condensed. The separation of vapors and liquid mixtures by nonporous membranes is due to the differences in the solubility and the diffusivity of the mixture components in the membrane material [31].

Pervaporation involves the separation of two or more components across a membrane by differing rates of diffusion through a thin polymer and an evaporative phase change comparable to a simple flash step. A concentrate and vapor pressure gradient is used to allow one component to preferentially permeate across the membrane. A vacuum applied to the permeate side is coupled with the immediate condensation of the permeated vapors. Pervaporation is typically suited to separating a minor component of a liquid mixture; thus high selectivity through the membrane is essential. Fig. 6-17 shows an overview of the pervaporation process.

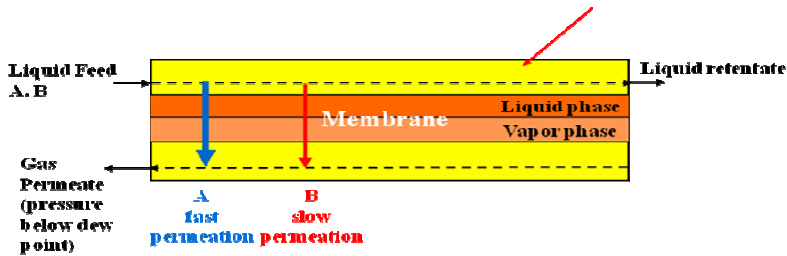

Fig. 6-17. The pervaporation process

The membranes used in pervaporation processes are classified according to the nature of the separation being performed [32]. Hydrophilic membranes are used to remove water from organic solutions. These types of membranes are typically made of polymers with glass transition temperatures above room temperature. Polyvinyl alcohol is an example of a hydrophilic membrane material. Organophilic membranes are used to recover organics from solutions. These membranes are typically made of elastomer materials (polymers with glass transition temperatures below room temperature). The flexible nature of these polymers makes them ideal for allowing organic constituents to pass through. Examples include nitrile, butadiene rubber and styrene butadiene rubber.

Liquid transport in pervaporation is described by various solution-diffusion models. The steps included are the sorption of the permeate at the interface of the solution feed and the membrane, diffusion across the membrane due to concentration gradients (rate determining steps), and finally desorption into a vapor phase at the permeate side of the membrane (Fig. 6-18). The first two steps are primarily responsible for the permselectivity. As material passes through the membrane a "swelling" effect makes the membrane more permeable, but less selective, until a point of unacceptable selectivity is reached and the membrane must be regenerated.

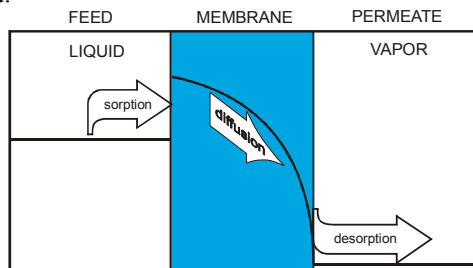

Fig. 6-18. Steps of the pervaporation process

The other driving force for separation is the difference in partial pressures across the membrane. By reducing the pressure on the permeate side of the membrane, a driving force is created. Another method of inducing a partial pressure gradient is to sweep an inert gas over the permeate side of the membrane. These methods are described as vacuum and sweep gas pervaporation, respectively (Fig. 6-19).

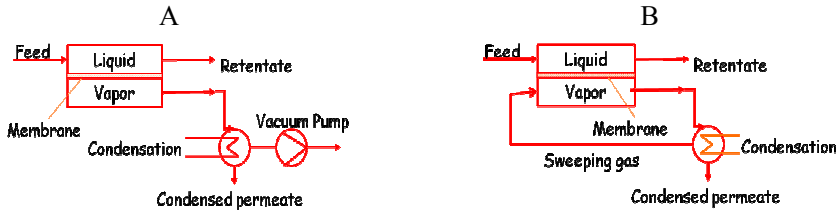

Fig. 6-19. Schematic drawing of the pervaporation process. A) downstream vacuum, B) inert carrier gas

Pervaporation can be used for:

- breaking azeotropes,
- dehydration of solvents and other volatile organics,
- organic/organic separations such as ethanol or methanol removal,
- wastewater purification.

Established industrial applications of pervaporation include:

- the treatment of wastewater contaminated with organics,
- pollution control applications,
- recovery of valuable organic compounds from process side streams,
- separation of 99.5% pure ethanol-water solutions,
- harvesting of organic substances from fermented broth.

The use of the pervaporation process has been involved in a recently popular application – the production of biofuels. The growing demand for biofuels has caused annual growth in the production of bioethanol. In 2008, world fuel ethanol production amounted to 65 mln m³ [33]. For ethanol to be added to gasoline, it may not contain more than 0.5% water since water found in ethanol can cause engine corrosion. Currently, the pervaporation process, in which membranes are applied, is most often used in achieving this objective (Fig. 6-20).

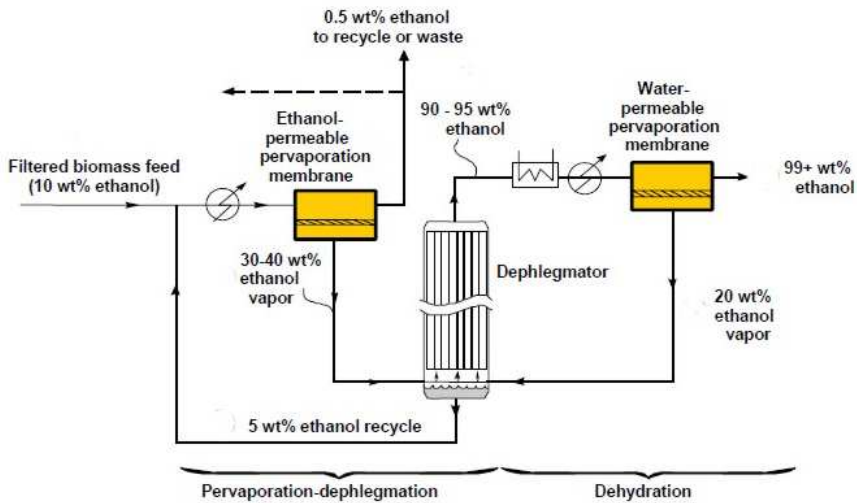

Fig. 6-20. Pervaporation application in ethanol dewatering (based on [34])

6.2.4. Liquid membranes

The majority of membranes used in different areas are in the solid phase; however, there are also liquid membranes in use. Liquid membranes separate two liquids or gases from each other. Transport from one phase to the other occurs when a chemical potential (concentration) gradient appears between those phases. Separation occurs because of differences in solubility and diffusivity in the liquid film [35].

There are two types of liquid membrane processes (Fig. 6-21):

1. emulsion liquid membrane (ELM) processes,
2. supported liquid membrane (SLM) processes.

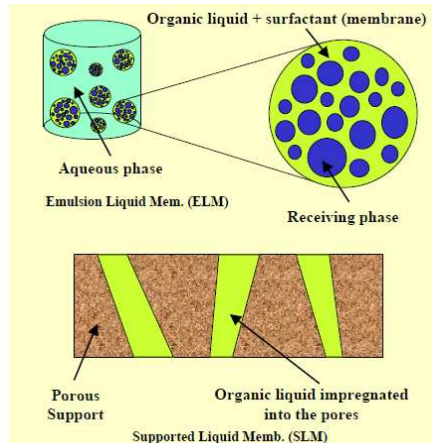

Fig. 6-21. Schematic drawing of liquid membranes

Both types of liquid membranes are conceptually similar, but differ in their engineering. Emulsion liquid membranes are multiple emulsions of water/oil/water or oil/water/oil types. The membrane phase is interposed between the continuous external phase and the encapsulated internal phase. The mass transfer area can be dramatically increased using this configuration. After extraction, the membrane phase is separated from the external phase and then the internal emulsion is broken into its component phases. With supported liquid membranes, the liquid membrane phase is held in place within a solid microporous inert support by capillary forces. Very high surface areas can also be obtained using this configuration.

Classical liquid membranes have a rather low selectivity. Selectivities are mainly based on differences in the distribution coefficients of the components in the donor phase to the liquid. If the components are similar, these differences are generally not very high. Much higher selectivities can be obtained by adding a carrier molecule to the liquid membrane. The carrier should possess a high affinity for one of the solutes in the donor phase. This type of transport is called carrier-mediated or facilitated transport. The idea of carrier-mediated transport is presented in Fig. 6-22. Four steps of the separation process can be distinguished:

1. at the feed (donor) phase/membrane interface, complexation takes place between the carrier B and solute A,
2. the carrier-solute complex diffuses through the membrane,
3. at the membrane/receiving (sweep) phase interface decomplexation takes place,
4. the free carrier diffuses back.

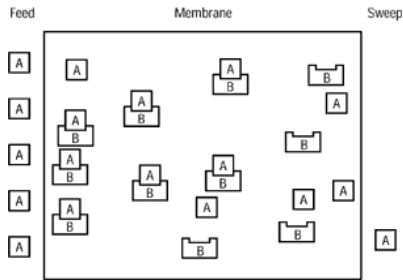

Fig. 6-22. Schematic depiction of a liquid membrane with carrier-mediated transport. (A denotes solute molecules and B denotes carrier molecules)

Requirements for materials used in liquid membrane preparation:

- low solubility in water,
- low volatility,
- low viscosity.

The most common solvents used in liquid membrane production are dibutyl phthalate, ortho-dichlorobenzene, 1-octanol, nitrophenyl n-octyl ether and nitrophenyl phenyl ether.

Liquid membranes can be applied for

- cation (Cu^{2+} , Hg^{2+} , Ni^{2+} , Cd^{2+} , Zn^{2+} , Pb^{2+}) and anion (NO_3^- , $\text{Cr}_2\text{O}_7^{2-}$, $\text{UO}_2(\text{SO}_4)_2^{2-}$) recovery,
- gas separation (O_2/N_2 , H_2S removal from natural gas, NH_3 , NO_x and SO_2 from waste gases),
- organic mixture separation (fractionation of hydrocarbons, phenol removal from water).

6.3. Thermal potential driven membrane processes

6.3.1. Membrane distillation

Membrane distillation (MD) is a thermally driven process. In this process, a microporous, hydrophobic membrane separates aqueous solutions at different temperatures and compositions. The temperature difference existing across the membrane results in a vapor pressure difference. Thus, vapor molecules are transported from the high vapor pressure side to the low vapor pressure side through the pores of the membrane.

Membranes used in membrane distillation should have the following characteristics [36]:

- the membrane should be porous (membrane porosity is the parameter which affects permeate flux. Higher membrane porosity corresponds to a larger diffusion area inside the membrane taking part in vapor transport. Higher porosity also reduces the amount of heat lost by conduction. Thus, a porosity higher than 70% is required. The recommended maximum pore radius amounts to 0.5-0.6 μm .),
- the membrane should not be wetted by process liquids (for aqueous solutions hydrophobic membranes made of polypropylene (PP), polytetrafluoroethylene (PTFE) or polyvinylidene fluoride (PVDF) are used),
- no capillary condensation should take place inside the pores of the membranes,
- only vapor should be transported through the pores of the membrane,
- the membrane must not alter vapor equilibrium of the different components in the process liquids,
- for each component the driving force of the membrane operation is a partial pressure gradient in the vapor phase.

The principle of direct contact membrane distillation is presented in Fig. 6-23. The process essentially involves the following steps:

- evaporation of volatile compounds of a feed at the warm feed/membrane interface,
- transfer of vapor through the membrane pores,
- condensation of the permeate at the membrane/cold distillate interface.

The separation mechanism is based on the vapor/liquid equilibrium. This means that the component with the highest partial pressure will exhibit the highest permeation rate. MD is a highly selective operation for non-volatile species such as ions, colloids and macromolecules which are unable to evaporate and diffuse across the membrane. The solutes are completely rejected and the permeate is then pure water. When volatile species are present in the feed they will also be transported through the membrane. According to the vapor/liquid equilibrium, permeate composition depends on the composition and temperature of a feed.

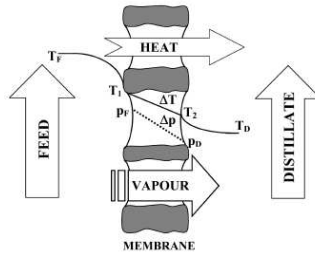

Fig. 6-23. Principles of the membrane distillation process. T - temperature, p - vapor partial pressure (F - feed and D – distillate) (based on [37])

Fig. 6-24 illustrates different MD configurations commonly used to obtain the required driving force. In all solutions the membrane is directly exposed to the warm solution, but the method of permeate condensation is different. In direct contact MD (Fig. 6-24A) the cold distillate is in direct contact with the membrane and vapor transported through the membrane condenses directly in a stream of cold distillate. In the gas-gap MD system (Fig. 6-24B), the permeate is condensed on a cooling surface. In this case, the total length of vapor diffusion is the sum of the membrane thickness and the air gap. The condensed distillate does not have to be in contact with the membrane. In a low pressure MD system (Fig. 6-24C), the pressure is applied on the distillate side and the condensation of the permeate takes place outside the module. In the last MD system, a sweeping gas is applied and permeate condensation occurs outside the module (Fig. 6-24D).

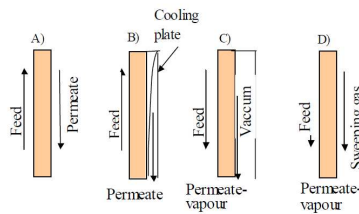

Fig. 6-24. Membrane distillation configurations: A) direct contact MD, B) air-gap MD, C) low pressure MD, D) sweeping gas MD (based on [38])

The practical application of membrane distillation can take three forms:

(1) preparation of pure, desalted or demineralized water from different sources.

The quality of MD distillate

- practically does not depend on the feed concentration (the conductance of permeate of $0.4 \mu\text{S}/\text{cm}$ due to the presence of dissolved gases),

- is better than from evaporators,
 - is fine particle, bacteria and pyrogene free;
- (2) increasing non-volatile substance solutions to high concentrations,
- in the food industry - fruits juice concentration, sugar juice concentration,
 - in pharmacy – concentration of vitamin solutions,
 - wastewater treatment and recovery of valuable chemicals;
- (3) recovery of volatile compounds from a solution
- separation of volatile fermentation products during ethanol production,
 - HCl recovery from industrial effluents.

In comparison with other desalination processes, the main advantages of membrane distillation are

1. 100% separation (in theory) of ions, macromolecules, colloids, cells etc.,
2. lower operating pressures,
3. lower requirements concerning the mechanical properties of the membrane,
4. less space required compared to conventional distillation processes.

6.4. Electrical potential driven membrane processes

6.4.1. Electrodialysis

Electro-membrane processes have been well known for many decades. The first electrodialyser was built in 1929. It contained only 3 cells with cation-exchange and anion-exchange membranes. Conventional electrodialysis (ED) was applied to industrial water desalination in 1952, whereas salt production from seawater by electrodialysis with monoselective membranes became possible in 1961. The first industrial plant for acid recovery (HNO_3/HF) from etching effluents with the use of electrodialysis with bipolar membranes was constructed in 1985.

Generally, in the electrodialysis process two streams can be obtained from one feed solution: concentrate and dialysate, also called diluate. In fact, it is a diluted stream. This is quite similar to the pressure driven processes, but there is a key difference between these processes: in pressure driven processes the treated water passes through the membrane whereas in electrodialysis the dissolved solids removed from the water pass through the membrane. The difference arises from the fact that ED is an electrical charge-driven process. Namely, a difference in electrical potential on both membrane sides is needed.

Electrodialysis, similarly to reverse osmosis, is used to remove salts, but in ED only ionic constituents of water can be separated.

Among the electro-membrane processes the following types can be distinguished:

- monopolar electrodialysis (classical) (ED),

- electrodialysis with a bipolar membrane,
- electrodialysis with a monoselective membrane,
- electrodialysis reversal (EDR),
- electrodeionization (EDI).

In the ED process an electric current supply and ion-exchange membranes are needed. Ions are transported through ion-exchange membranes. These membranes are set up like a sandwich with an anion-exchange membrane followed by a cation-exchange membrane. Two membranes of opposite charge constitute one cell. Fig. 6-25 presents a set of ion exchange membranes. These membranes are placed between electrodes: an anode and a cathode. After switching the electric field on, the electromigration of ions takes place. Cations migrate to the cathode through cation-exchange membranes, whereas anions migrate to the anode through anion-exchange membranes. As a result of such migration two streams are obtained: dialysate and concentrate. In Fig. 6-25 sodium ions as cations are transported through cation-exchange membranes. Chloride ions as anions are transported through anion-exchange membranes.

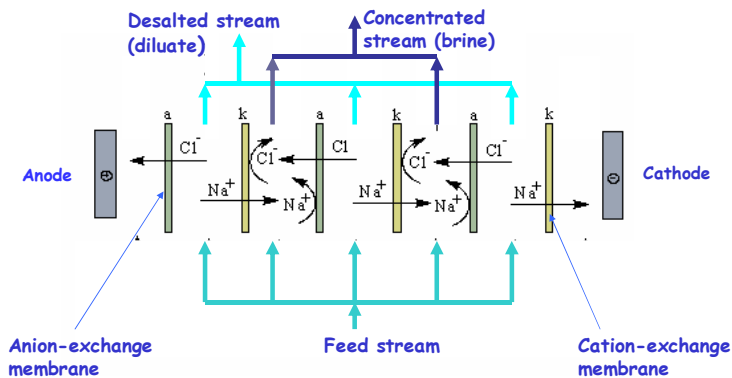

Fig. 6-25. The principle of electrodialysis

The basic ED rules can be summarized as follows:

- transport of ions through alternately set pairs of ion-exchange membranes – anion-exchange and cation-exchange membranes,
- ion transport is caused by the difference in electric potential on both membrane sides, i.e. electric current is needed,
- effect of the process – 2 streams: desalted and concentrated,
- desalted stream (diluate) is the feed water from which the cations and anions have been removed,

- concentrated stream – the stream in which the cations and anions removed from the diluate stream have been concentrated.

In electrode cells, near the electrodes, chemical reactions take place. Depending on the type of feed water and pH some gases and solids can be emitted at the electrodes:

- in the electrodialysis of seawater having a basic pH sodium hypochlorite can be emitted at the anode,
- in the electrodialysis of seawater having an acidic pH chlorine can be emitted at the anode,
- in the electrodialysis of water containing sulfates oxygen can be emitted at the anode,
- hydrogen can be emitted at the cathode.

Generally, ion-exchange membranes are made of various polymers that are rather hydrophobic in nature. These membranes are modified in order to obtain a negative or positive charge from suitable functional groups. In Fig. 6-26 the cross-section of a cation-exchange membrane is given. This membrane has a large number of negative charges meaning it has a high negative charge density. Thus, in the electric field only cations can enter the membrane, whereas anions will be excluded from the membrane matrix. The negative ions in the membrane are called fixed ions and the negative ions in the solution are called co-ions. The positive ions in the water are called counter ions.

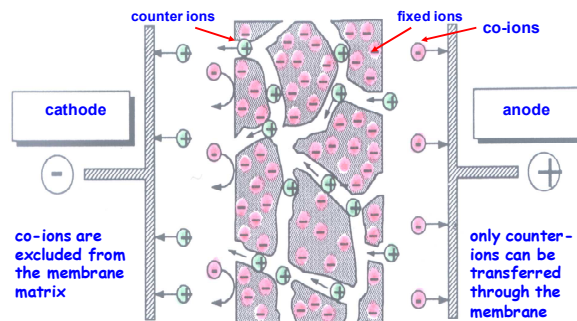

Fig. 6-26. Transport of ions in the cation-exchange membrane – the exclusion principle (based on [39])

Among ion-exchange membranes it is worth distinguishing the following types:

- monoselective ion-exchange membranes,
- bipolar membranes.

Monoselective membranes (Fig. 6-27) are used to separate mono-valence ions from multi-valence ions of the same sign. Through monoselective membranes only mono-valence ions can be transported. This effect is due to the presence of an additional membrane layer of opposite charge. The electrostatic interaction between this layer and multi-valence ions is very intense; however, small mono-valence ions can overcome this barrier and pass through the membrane.

Bipolar membranes (Fig. 6-28) consist of two layers: an anion-exchange layer and a cation-exchange layer. Between them there is a water layer having a thickness of about 1-2 nm. In the electric field, water electrolysis takes place: hydrogen and hydroxyl groups can be generated from a bipolar membrane.

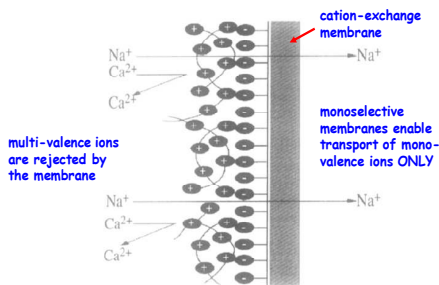

Fig. 6-27. Mono-cation-exchange membrane (based on [40])

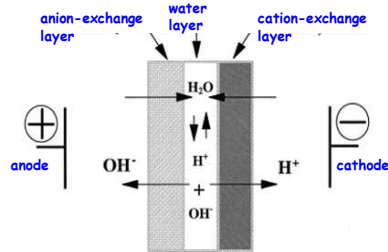

Fig. 6-28. Bipolar membrane (based on [40])

Ion-exchange membranes must fulfill many conditions. They should achieve:

- high selectivity towards one type of ion,
- low electrical resistance,
- high ion-exchange capacity,
- high mechanical durability,
- high chemical resistance.

A low electrical resistance is very important because this translates into a lower energy demand for the process. A low electrical resistance can be obtained by adding many functional groups to the membrane matrix, but this can cause negative effects in that the membrane will be less chemically and mechanically resistant. Ion-exchange membranes are applied in the entire pH range so they must be chemically and mechanically stable. This can be achieved by the high cross-linking of polymer, but in this case the electrical resistance of the membranes increases. For this reason, an optimization procedure should be applied in membrane preparation and selection.

The most common functional groups, the so called fixed ions, can be the following:

- for cation-exchange membranes:
 SO_3^- (sulfonic), COO^- (carboxylic), PO_3^{2-} (phosphonium);
- for anion-exchange membranes:
 NH_3^+ , RNH_2^+ , R_3N^+ (various ammonium groups – of the first, second, third order, respectively).

Ion-exchange membranes are mainly produced in Japan. The standard membrane thickness is around 0.15-0.3 mm, whereas the electrical resistance is equal to 1.5-4.5 Ωcm . As the membrane selectivity approaches 1, the membrane becomes more ideal.

Electrodialysis takes place in an electrolysiser (ED stack), i.e. a setup consisting of tightening boards with electrodes (the anode on one end and the cathode on the second end) and a stack of ion-exchange membranes and spacers (Fig. 6-29). A typical stack consists of about 500 membranes with flow channels between membranes. One-half of the membranes are made of anion-exchange resins and one-half are made of cation exchange resin. The membranes are arranged as a repeating set of cell pairs like a sandwich. Between the membranes special spacers are placed.

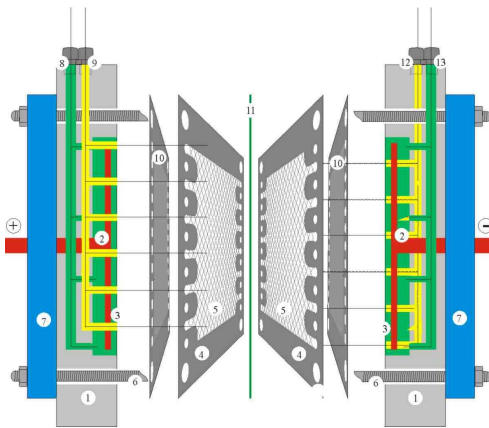

1 – end plate, 2 – electrode, 3 – electrode chamber, 4 – spacer-sealing PVC, 5 – spacer fabric, 6 – screws, 7 – steel frame, 8 – inlet anode cell, 9- inlet concentrate cell, 10 – cation-exchange membrane, 11- anion-exchange membrane, 12 – inlet diluate cell, 13 – inlet cathode chamber

Fig. 6-29. Cross-section of an electrolysiser stack [41]

The membrane spacers are very important because they

- keep the suitable distance between the membranes,
- enable uniform flow of dialysate and concentrate streams at the membrane surface.

Two types of spacers are available:

- sheet flow spacer – provides a low liquid velocity and a low pressure drop,
- tortuous path – provides a high liquid velocity and a high pressure drop.

It should be recognized that a greater velocity at the membrane surface leads to a reduction in the concentration polarization effect. The spacer itself looks like a polymer net with very small mesh. The tortuous spacer has additional elements mounted perpendicular to the spacer surface.

The most important parameters in ED economics and the design approach are as follows:

- power demand,
- current efficiency,
- limited current density,
- membrane area,
- treatment efficiency.

The energy requirement for ED process involves

- energy for ion transport from the dialysate cell to the concentrate cell (E),
- energy for solution pumping through the ED stack (E_p).

The energy for ion transport (E) is given by the following equation:

$$E = \frac{InRtFQ\Delta S}{\eta_p} \quad (6-1)$$

where:

E – energy demand, Ws (Wh)

I – current intensity, A

n – number of cell pairs in the ED stack

R – cell resistance, Ω

t – time, s (h)

F – Faraday constant, As/eq

Q – volume flow, m^3/s

η_p – current efficiency

ΔS – the change in the diluate concentration from inlet to outlet, eq/m^3 .

The pumping energy E_p is given by the following equation:

$$E_p = k_1 Q_d \Delta P_d + k_2 Q_b \Delta P_b + k_3 Q_c \Delta P_c \quad (6-2)$$

where:

E_p – pumping energy, Ws (Wh)

k_1, k_2, k_3 , - constants

Q_d, Q_b, Q_c – volume flow of diluate, concentrate and electrode solution, m³/s

$\Delta P_1, \Delta P_2, \Delta P_3$ – pressure drops.

For economic reasons it is important to determine the energy demand per volume of treated water or per amount of removed charge. This specific energy demand W_e is given by equations 6-3 and 6-4, respectively:

$$W_e = \frac{E_c}{L_{ac}} = \frac{I \cdot \sum U \cdot \Delta t}{L_{ac}} \quad (6-3)$$

$$W_e = \frac{E_c}{V} = \frac{I \cdot \sum U \cdot \Delta t}{V} \quad (6-4)$$

where:

E_c – total energy demand, Wh

L_{ac} – total cations or anions removed (expressed as equivalent concentration), eq

V – volume of treated solution (volume of dialysate with the assumption that $V_{initial} = V_{final} = V$), m³.

Equation 6-3 gives the specific energy demand per equivalent of removed ions, whereas equation 6-4 represents the specific energy demand per cubic meter.

In practice, it is possible to calculate energy demand on the basis of the relationship between the measured voltage versus time of the process. The following equation is taken into account:

$$E = I \cdot U \cdot t \quad (6-5)$$

where:

I – current intensity, A

U – voltage (measured during process), V

t – time of the process, h.

The surface area under the curve determined by the relationship $U = f(t)$ should be determined.

The current efficiency η_p is given by the following equation:

$$\eta_p = \frac{\mathcal{L}_{ac}}{\mathcal{L}_{th}} \cdot 100\% \quad (6-6)$$

where:

\mathcal{L}_{ac} – actual total amount of cations or anions removed from the dialysate cell to the concentrate cell (expressed as equivalent concentration), eq

\mathcal{L}_{th} – theoretical total amount of cations or anions removed from the dialysate cell to the concentrate cell (expressed as equivalent concentration), eq.

Generally, the current efficiency takes values of 85 to 95%. In reality, electro dialysis systems never reach 100% efficiency due to the following reasons:

- some current is used for H^+ and OH^- ion transport,
- osmotic transport of water – water is “running away” from the dialysate cell to the concentrate cell,
- electro-osmotic transport of water – each ion carries a water layer,
- reverse diffusion of ions from concentrate cell to dialysate cell,
- membranes are not perfect (also some co-ions are passing).

The amount of actual total ions removed is given by the equation:

$$\mathcal{L}_{ac} = V_i S_i - V_f S_f \quad (6-7)$$

where:

V_i – initial volume of dialysate, m^3

V_f – final volume of dialysate, m^3

S_i – initial total concentration of cations or anions in the dialysate cell, eq/m^3

S_f – final total concentration of cations or anions in the dialysate cell, eq/m^3 .

It is often assumed that $V_{initial} = V_{final} = V$.

Faraday’s law gives the relationship between the electrical charge measured in amperes and ions transported through the membrane. The theoretical amount of ions removed for one cell pair is given by the equation:

$$\mathcal{L}_{th} = \frac{I \cdot t}{F} \quad (6-8)$$

where:

I – current intensity, A

t – time of the process, s

F – Faraday constant, 96500 As/eq.

For n cell pairs:

$$\mathcal{L}_{th} = \frac{n \cdot I \cdot t}{F} \quad (6-9)$$

where n denotes the number of dialysate cells.

For further calculations, it is convenient to introduce the parameter called *current density* (i) by dividing the current intensity by membrane area:

$$i = \frac{I}{A} \quad (6-10)$$

where

A – membrane area desired for some desalination effect, m²

I – current intensity, A.

Thus for 1 cell pair:

$$\mathcal{L}_{th} = \frac{I \cdot t}{F} = \frac{i \cdot A \cdot t}{F} = \frac{\mathcal{L}_{ac}}{\eta_p} = \frac{V(S_i - S_f)}{\eta_p} \quad (6-11)$$

From equation 6-11 the desired membrane area for one cell pair can be calculated:

$$A = \frac{F \cdot V \cdot \Delta S}{\eta_p \cdot i \cdot t} \quad (6-12)$$

(with the assumption $V_{initial} = V_{final} = V$)

Thus, for n pair cells:

$$A^+ = A^- = \frac{nFV\Delta S}{\eta \cdot i \cdot t} \quad (6-13)$$

The current density can be regarded as the driving force of the process since it determines the quantity of equivalent grams that are transported across the membrane. Running at a high current density reduces the required surface of ED membranes making the process more attractive. However, this has to be balanced with a disproportionate cell voltage increase resulting in much higher power consumption. Also, as the current density increases, a concentration polarization effect can be observed – the ions are transported faster across the membrane than they are transported in the cell solution to the membrane surface (see paragraph 7.3). This results in a very quick increase in cell voltage and a dramatic worsening of process efficiency due to the increase in electrical resistance and water dissociation. Thus, the limiting current density is connected with concentration polarization and it is the maximum allowed current density that can be reached avoiding a steep increase in cell voltage. Thus, for a given application, it is important to determine this critical parameter by plotting a polarization curve, i.e. current intensity versus voltage.

ED membranes as well as ED installations are very sensitive to various impurities present in the feed solution. Due to the fouling hazard, the solution entering the ED stack should be free of

- suspended matter and colloidal substances,
- ferric (iron) and manganese compounds (fouling hazard):
 $\text{Fe}^{2+} < 0.3 \text{ g/m}^3$, $\text{Mn}^{2+} < 0.1 \text{ g/m}^3$.

The prevention of scaling (precipitation of salts at the membrane surface) can be achieved by

- acid dosage into brine (concentrate) stream (calcium carbonate CaCO_3 will not be precipitated),
- dosage of scaling inhibitors (sulfates such as CaSO_4 , BaSO_4 , SrSO_4 will not be precipitated and crystal formation will be delayed).

A typical ED installation consists of a pretreatment process, low-pressure pump, microfiltration unit, ED stack and current supply (Fig. 6-30). Generally, the product stream should be subjected to post-treatment such as gas removal, pH adjustment and disinfection.

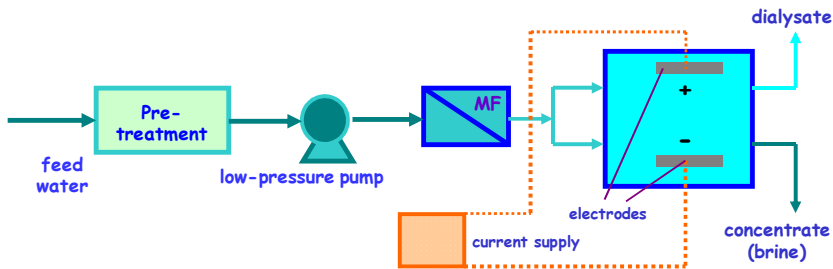

Fig. 6-30. Electro dialysis installation

Depending on the process objectives, the ED stacks can operate in parallel or in series. In a parallel configuration, according to the scheme in Fig. 6-31, the feed stream is divided into 3 streams passing through 3 parallel stacks and the recirculation of brine is possible. After the ED process, the dialysate streams are connected together. In a parallel arrangement the quality of diluate is the same in each sub-stream and it is possible to increase the total capacity of the ED system. The serial stack configuration, on the other hand, enables improving the product quality. As shown in Fig. 6-32, the ED stacks are connected in series, one after another, so the quality of dialysate after each stage is improved. However, the total capacity of the ED system is not changed. In each stack the 30-50% reduction of

salt concentration can be achieved; thus, at an initial salt concentration of 3000 g/m^3 it is possible to reach a final salt concentration equal to 500 g/m^3 .

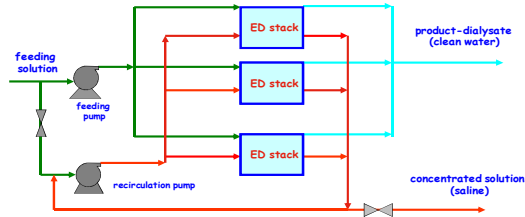

Fig. 6-31. Parallel configuration of ED stacks

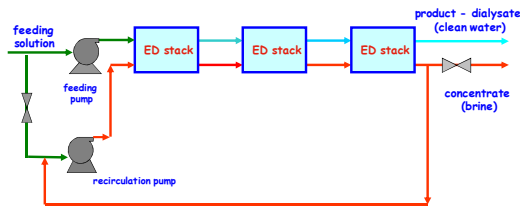

Fig. 6-32. Serial configuration of ED stacks

Taking into account the operating mode, the ED installations can work as continuous or batch systems. In the continuous system (Fig. 6-33) the feeding solution passes the ED stack only once whereas partial recirculation of brine solution occurs. In this system it is possible to mix the concentrate stream with feed water enabling concentrate dilution. Conversely, in the batch system (Fig. 6-34) the recirculation of dialysate and concentrate streams takes place and both streams pass the ED stack many times to reach the desired concentration or purity. In the course of the process part of the concentrate stream could be discharge as wastewater. In order to dilute the concentrate stream, mixing with the feed solution is also possible.

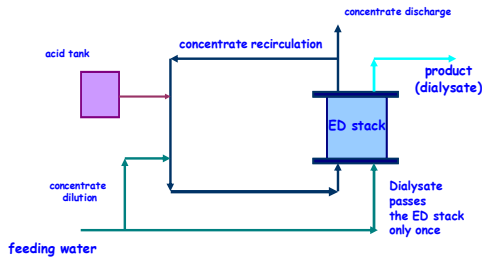

Fig. 6-33. Continuous operation mode of an ED installation

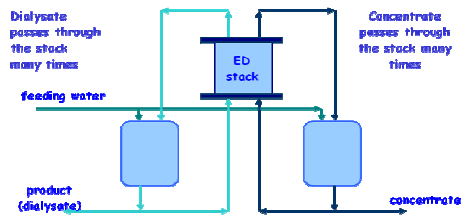

Fig. 6-34. Batch operation mode of an ED installation

6.4.2. Electrodialysis reversal

Electrodialysis reversal (EDR) systems incorporate electrical polarity reversal to control membrane scaling and fouling. These systems are designed to continuously produce demineralized water without continuous chemical addition during normal operation.

Electrodialysis reversal (Fig. 6-35) is the variation of the conventional ED process. The difference between ED and EDR is that the electrical potential applied to the stack is reversed from time to time (2 to 4 times per hour for 1-2 minutes). When the DC power polarity is reversed, the diluate and brine cells are also reversed - the dialysate cell becomes the concentrate cell and the concentrate cell turns into the dialysate cell. The cathode becomes the anode and the anode becomes the cathode. The ions then move in the opposite direction. This alternating exposure of membrane surface to the product and concentrate streams provides a self-cleaning capability that enables desalting of scaling or fouling solutions. In this respect, the tendency for precipitate formation at the membrane surface is reduced. Finally, the negative effect of concentration polarization is minimized and the recovery of up to 90-95% of feed water is possible.

In EDR electrode compartments perform a different function compared to those in conventional ED systems. When polarity is reversed, chemical reactions at the electrodes are reversed. At the negative electrode reactions produce hydrogen gas and hydroxide ions. Hydroxide raises the water pH causing calcium carbonate (CaCO_3) precipitation. At the positive electrode reactions produce acid, oxygen, and some chlorine. The acid tends to dissolve any calcium carbonate precipitate, thus inhibiting scaling. Because of the corrosive nature of the anode compartments, electrodes are constructed of an inert metal, usually platinum coated titanium.

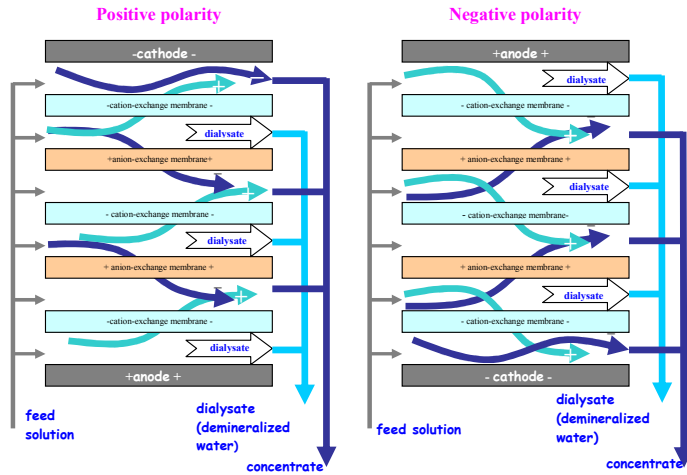

Fig. 6-35. Electrode reversal (EDR) (based on [42])

The superiority of EDR over conventional ED systems results from

- detaching polarization films,
- breaking up freshly precipitated scale or seeds of scale before they can cause damage,
- reducing slime formation on membrane surfaces,
- reducing problems associated with the use of chemicals,
- cleaning electrodes with acid automatically during anodic operation.

6.4.3. Electrodialysis with bipolar membranes

The essential characteristic of electrodialysis with bipolar membranes (EDBM) is the combination of conventional electrodialysis for salt separation with electrodialysis water splitting for the conversion of a salt into its corresponding acid and base without chemical addition. Bipolar membranes induce the splitting of water into protons and hydroxide ions.

As already mentioned in paragraph 6.4.1, bipolar membranes consist of a cation-exchange membrane, an anion-exchange membrane and an intermediate water layer between them (Fig. 6-27). The main requirements for a bipolar membrane are

- excellent long-term stability,
- a low passive drop in potential,
- a high rate of water splitting,

- high permselectivity,
- good mechanical stability.

Under the driving force of an electrical field, a bipolar membrane can efficiently dissociate water into hydrogen (H^+) and hydroxyl (OH^-) ions. The transport out of the membrane of the H^+ and OH^- ions obtained from the water splitting reaction is possible if the bipolar membrane is oriented correctly (there is no current reversal in water splitting). With the anion-exchange side facing the anode and the cation-exchange side facing the cathode, the hydroxyl anions will be transported across the anion-exchange layer and the hydrogen cations across the cation-exchange layer. Therefore, a bipolar membrane allows the efficient generation and concentration of hydroxyl and hydrogen ions at its surface. These ions are used in an electro dialysis stack to combine with the cations and anions of the salt to produce acids and bases.

The simplest design for bipolar membrane processes is the so-called three-chamber stack. In this case, the recurring membrane unit in the stack is composed of one bipolar membrane, one cation-exchange membrane and one anion-exchange membrane. This kind of membrane configuration forms three compartments: acid between the bipolar and the anion-exchange membranes, base between the bipolar and the cation-exchange membranes, and salt (in fact diluted salt) between the cation- and anion-exchange membranes (Fig. 6-36).

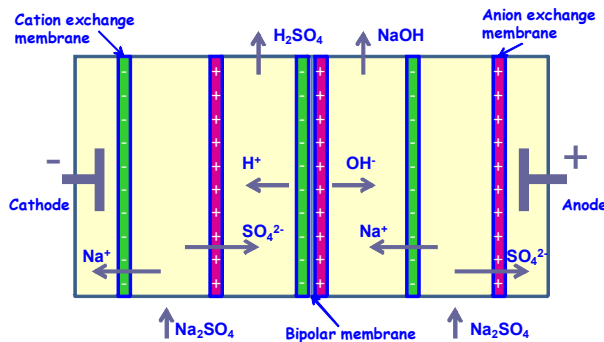

Fig. 6-36. Electrodialysis with a bipolar membrane (three-compartment-cell) (based on [43])

It becomes easy to see how, by feeding the salt solution to the salt compartments, water to the acid and base compartments and by supplying a DC current across the electrodes, it is possible to convert an aqueous salt solution such as Na_2SO_4 into the base NaOH and the acid H_2SO_4 . In the electric field, the anions (e.g sulfate ions) migrate through the anion-exchange membrane to the anode, are

then retained on the cation-selective side of the bipolar membrane and finally form e.g. sulfuric acid together with the protons produced in the bipolar membrane. Similarly, caustic soda solution is formed on the anion-selective side of the bipolar membrane while a diluate is produced in the outer chambers. In this manner other salts such NaCl, KF, NH₄Cl, KCl, etc., as well as the salts of organic acids and bases can be converted.

There are two other main configurations that can be commonly considered: two-compartment cells with bipolar and cation-exchange membranes (only) or with bipolar and anion-exchange membranes. Using a two-compartment configuration may only be feasible in some cases and brings economic benefits such as lower investment costs (one less loop, fewer membranes) and a lower operating cost (lower power, fewer membranes to replace).

6.4.4. Electrodeionization

Electrodeionization (EDI) is a new technology used commercially in the beginning of the 21st Century mainly in Europe, the United States and India. It is a new method for the continuous production of high purity water. This method couples the ion exchange (IE) and electrodialysis (ED) processes that work simultaneously during operation. It was developed to overcome the limitations of ion exchange resin beds, notably the release of ions as the beds become exhausted and the associated need to change or regenerate the resins. The advantages of EDI technology (in comparison to ED and IE) are as follows:

- lower power demand,
- much better product quality (ultra-pure water),
- continuous production,
- lack of chemical reagents for regeneration,
- lack of aggressive wastewaters.

An electrodeionization unit uses the electrodialysis process which requires energy. The ion exchange resin in the EDI unit is provided as a base material for the removal of residual dissolved solids present in the water. The resin exchanges its functional group with the dissolved ions of the water as occurs in the conventional mixed bed unit. Thus, the water has dissolved impurities removed and pure water is produced. The resin has to be regenerated to work further and this is done by electrolysis. The electrolysis is employed in EDI to dissociate water into H⁺ and OH⁻ ions which regenerate the resin and replace the dissolved positive and negative ions from the resin. These undesirable ions are removed from the diluate cell by passing ion-exchange membranes towards proper electrodes.

The main disadvantage of conventional ED consists of incomplete demineralization because demineralized water requires lack of ions in the dialysate cell. As a consequence, water electrolysis occurs and current efficiency decreases. In the EDI process, dialysate cells are filled with ion-exchange grains. This ion-exchange resin is a source of ions and the current can be transferred through the ED stack.

Fig. 6-37 presents the main idea of the electrodeionization process. The EDI feed water is passed through the diluate chambers which are filled with ion exchange resin. Through the action of the electric field the anions migrate through the resin bed in the direction of the anode. As a result, they pass through the anion-permeable membrane and arrive in the adjacent stream of concentrate. The cations migrate through the resin bed in the direction of the cathode, pass through the cation-permeable membrane, and likewise enter the stream of concentrate. With the concentrate stream the ions are expelled from the module. The electrolyte stream flushes out the gases that are created at the electrodes along with the ions and carries them out of the module. As a result of the electrical voltage, water splitting (electrolysis) occurs in the resin bed of the diluate chamber. The H^+ and OH^- ions that are needed for the regeneration of the exchange resin are created. These ions regenerate the resin bed on an ongoing basis. In this way continuous operation can be maintained without any need to switch off the system for regeneration.

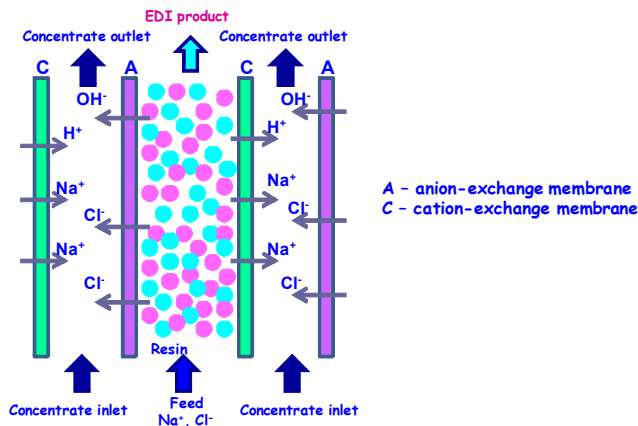

Fig. 6-37. The electrodeionization process (based on[44])

The value of applied voltage is very important because too low of a voltage produces too few generated ions H^+ and OH^- while too high of a voltage results in too many generated ions H^+ and OH^- that can compete with removed ions.

EDI technology is typically used to polish reverse osmosis (RO) permeate and to replace conventional mixed ion exchange beds. This process is applied as post-treatment to produce very high purity water for power generation and pharmaceutical applications. Typically, EDI product water has a resistivity of 1 to 18.2 MΩcm, total organic carbon content below 10 µg/dm³ and a silica concentration below 5 µg/dm³. Although EDI systems enable 90-95% water recovery, they have the following disadvantages:

- high investment costs,
 - feed water of high quality (the best is RO permeate),
- sensitivity to water pollutants (suspended mater, colloids, metal ions, carbonates, sulfates).

7. MASS TRANSPORT AND PERMEATE FLUX CHANGES IN MEMBRANE PROCESSES

During actual separation, membrane performance can change greatly and often a sharp decrease of permeate flux over time is observed (Fig. 7-1). The extent to which this phenomenon occurs is strongly dependent on the kind of applied process. Especially in microfiltration and ultrafiltration, the flux decline is very severe with the process flux often being less than 5% that of pure water [16]. In contrast, the problem is less severe in gas separation and pervaporation.

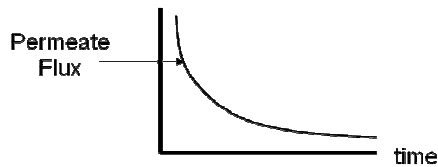

Fig. 7-1. Flux changes as a function of time

The flux of pure water across a membrane is often described by Darcy's law:

$$J = \Delta p / \mu \cdot R_m \quad (7-1)$$

where Δp is the transmembrane pressure, μ is the absolute viscosity of water and R_m denotes membrane resistance.

Approximate values of membrane resistance for pressure driven membrane processes are listed in Table 9.

Table 9. Approximate values of membrane resistance [11]

| Process | R_m, m^{-1} |
|---------|---------------|
| RO | 10^{10} |
| NF | 10^8 |
| UF | 10^7 |
| MF | 10^6 |

However, when a solution containing various substances undergoes membrane filtration, the resistance of the membrane system increases and the above equation has the following form:

$$J = \Delta p / \mu \cdot R_{tot} \quad (7-2)$$

where R_{tot} contributes to the total resistance of the membrane system. The decline in flux can be caused by several factors such as concentration polarization, adsorption, gel layer formation and plugging of the pores. Fig. 7-2 provides a schematic representation of various resistances that can arise.

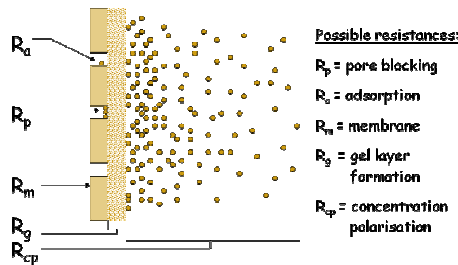

Fig. 7-2. Overview of various types of resistance towards mass transport across a membrane

The various resistances depicted in Fig. 7-2 contribute to different extents to the total resistance. In the ideal case, only the membrane resistance R_m is involved. Because the membrane has the ability to transport one component more readily than other components or in some cases to completely retain the solutes, there is an accumulation of retained molecules near the membrane surface. This results in the formation of a highly concentrated layer near the membrane called the concentration polarization layer. This layer exerts a resistance towards mass transport, i.e. the concentration polarization resistance R_{cp} . The concentration of the accumulated solute molecules may become so high that cake deposits (in the case of inorganic substances or solids) or a gel layer can be formed. This layer exerts the gel or cake layer resistance R_g . With porous membranes it is possible for some

solutes to penetrate into the membrane structure and block the pores, leading to pore-blocking resistance R_p . Finally, resistance can arise due to adsorption phenomena, i.e. the resistance R_a . Adsorption can take place upon the membrane surface as well as within the pores.

7.1. Concentration polarization in pressure driven membrane processes

One of the critical factors determining the overall performance of a membrane system is the rate of solute or particle transport in the feed side from the bulk solution toward the membrane. As shown in Fig. 7-3, pressure-driven flow across the membrane convectively transports solutes toward the upstream surface of the membrane. If the membrane is partially or completely retentive to a given solute, the initial rate of the solute transport toward the membrane will be greater than the solute flux through the membrane. This causes the retained solute to accumulate at the upstream surface of the membrane. This phenomenon is generally referred to as concentration polarization, i.e., a reversible mechanism that disappears as soon as the operating pressure has been released. The solute concentration of the feed solution adjacent to the membrane varies from the value at the membrane surface, C_{wall} , to that in bulk solution, C_{bulk} , over a distance equal to the concentration boundary layer thickness, δ . The accumulation of solute at the membrane surface leads to a diffusive back flow toward the bulk of the feed. Steady state conditions are reached when the convective transport of solute to the membrane is equal to the sum of the permeate flow plus the diffusive back transport of the solute.

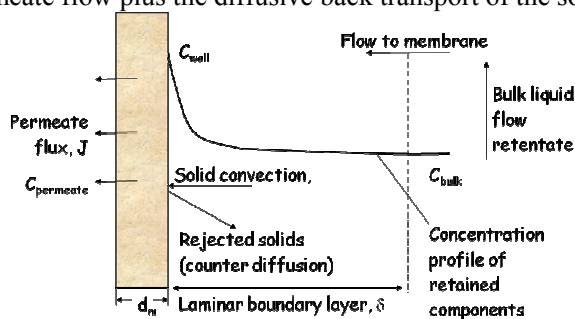

Fig. 7-3. Concentration polarization profile

The accumulation of solutes/particles at the membrane surface can affect the permeate flux in two distinct ways. First, the accumulated solute can generate an osmotically driven fluid flow back across the membrane from the permeate side toward the feed side, thereby reducing the net rate of solvent transport. This effect generally will be most pronounced for small solutes which tend to have large

osmotic pressures (e.g., retained salts in reverse osmosis). However, very high concentrations of dextran and whey protein solutions at the membrane surface can also have a substantial osmotic pressure. Second, the solutes/particles can irreversibly foul the membrane due to specific physical and/or chemical interactions between the membrane and various components present in the process stream. This provides an additional hydraulic resistance to the solvent flow in series with that provided by the membrane. These interactions can be attributed to one or more of the following mechanisms:

- adsorption,
- gel layer formation,
- plugging of the membrane pores.

Their severity depends on the membrane material, the nature of solutes and other variables such as pH, ionic strength, solution temperature and operating pressure.

The consequences of concentration polarization can be summarized as follows:

- decrease of retention – in the case of low molecular weight solutes, due to an increase in their concentration at the membrane surface and an increase in osmotic pressure;
- increase of retention – for solutions containing macromolecular solutes which are completely retained by the membrane a dynamic membrane forms. This results in a higher retention of low molecular weight solutes;
- decrease of permeate flux – formation of a boundary layer results in an increase in total membrane resistance.

Polarization phenomena always occur and are inherent to membrane separation processes, although they are more severe for processes with high permeate fluxes (MF, UF). The intensity of concentration polarization may be decreased by

- decreasing the flux J , by the decrease of the driving force value,
- increasing the mass transfer coefficient, by the increase of solute diffusivity and feed velocity along the membrane.

7.2. Membrane fouling in pressure driven membrane processes

Analyzing the changes of permeate flux over time (Fig. 7-4), it is evident that when only taking into account concentration polarization after reaching steady state conditions the flux should become constant as a function of time. In practice, however, a continuous decline in flux is observed. Such continuous flux decline is the result of membrane fouling, which is defined as reversible or irreversible

deposition of retained particles, colloids, emulsions, suspensions, macromolecules, salt etc. on or in the membrane.

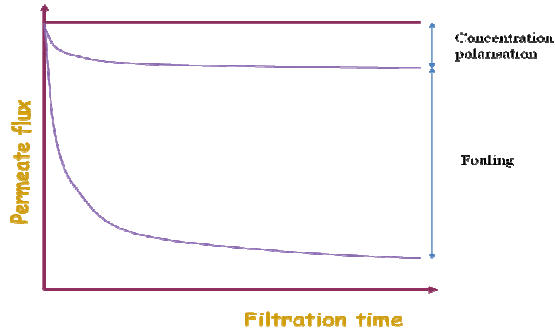

Fig. 7-4. The decrease of membrane permeability due to concentration polarization and fouling

Accumulated materials (Fig. 7-5) produce an additional layer on the membrane surface or enter membrane pores. External fouling (generally reversible) occurs on the top surface of the membrane due to the accumulation of cells or large particles that do not enter the pores, whereas internal fouling (generally irreversible) occurs within the internal pore structure of the membrane due to the deposition and adsorption of small particles and proteins or other macromolecules which are able to pass into the pores.

In case of external fouling, hydraulic permeability and solute transmission characteristics are altered due to

- increase in the effective membrane thickness,
- blockage of pore entrance,
- constriction of pore entrance.

When internal fouling occurs, hydraulic permeability and solute transmission characteristics are altered due to

- internal blockage of pores,
- internal constriction of pores,
- alteration of pore tortuosity.

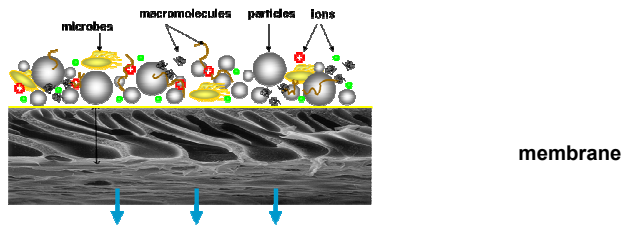

Fig. 7-5. The accumulation of materials at the membrane surface (based on [45])

The following types of membrane fouling are distinguished:

- inorganic fouling (scaling)– caused by precipitated metal hydroxides, sulfides and carbonates,
- particulate fouling - caused by suspended solids and colloids,
- biological fouling (biofouling)- caused by microorganisms,
- organic fouling - caused by natural organic matter and other organic substances.

Mineral salt scaling (Fig. 7-6) is the major foulant limiting the recovery in reverse osmosis desalination processes. The primary mineral salt scalants that are typically of concern in inland water desalination are calcite, gypsum, and barite. Formed crystals may block the membrane surface as well as penetrate the membrane structure causing irreversible damage.

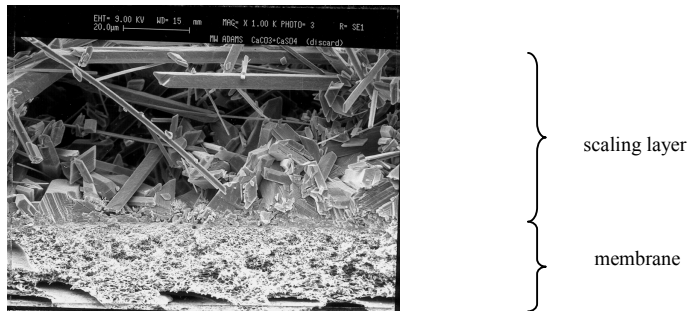

Fig. 7-6. Membrane scaling due to precipitated CaCO_3 and CaSO_4 (based on [45])

Biofouling is provoked by aerobic and anaerobic living material such as bacteria, fungus, algae as well as by metabolic products generated by these species. Microorganisms that are present in low concentrations in the feed may grow in membrane systems into massive quantities that effectively block flow through the membrane surface.

The phenomenon of membrane fouling is very complex and difficult to describe. As the main factors affecting membrane fouling, the following items are considered:

- physicochemical properties of the membrane
 - ⇒ *hydrophobicity, electrostatic charge, reactive groups,*
- physicochemical properties of the solute
 - ⇒ *molecular weight, hydrophobicity, electrostatic charge, shape,*
- membrane morphology
 - ⇒ *pore shape, straight pores vs. pore network,*
- operating parameters
 - ⇒ *TMP, permeate flux, system hydrodynamics,*
- physicochemical parameters of the feed solution
 - ⇒ *solute concentration, pH, salt concentration,*
- membrane operation history.

There are 4 main groups of methods to reduce fouling:

- pre-treatment of the feed solution
 - a. heat treatment,
 - b. pH adjustment,
 - c. addition of complexing agents,
 - d. chlorination,
 - e. adsorption onto activated carbon,
 - f. chemical clarification,
- proper choice of membrane properties
 - a. narrow pore size distribution,
 - b. hydrophilic membranes,
- module and process conditions
 - a. reducing concentration polarization,
 - increasing flux velocity,
 - using low flux membranes,
 - b. turbulence promoters,
- membrane cleaning
 - a. hydraulic cleaning,
 - b. mechanical cleaning,
 - c. chemical cleaning,
 - d. electric cleaning.

The choice of method to decrease the intensity of membrane fouling depends on

- quantities (characteristic) of each foulant,

- nature of the membrane filter,
- economic considerations,
- production demands.

In industry, apart from feed pretreatment, the most commonly used method of preventing membrane fouling is membrane cleaning. There are several different membrane cleaning methods such as forward flush, backward flush, air flush and chemical cleaning. The concept of hydraulic membrane cleaning is presented in Fig. 7-7.

When forward flush is applied, membranes are forward flushed with feed water or permeate. The feed water or permeate flows through the system more rapidly than during the production phase. Because of the more rapid flow and the resulting turbulence, particles that are absorbed to the membrane are released and discharged. The particles that are absorbed to membrane pores are not released. These particles can only be removed through backward flushing.

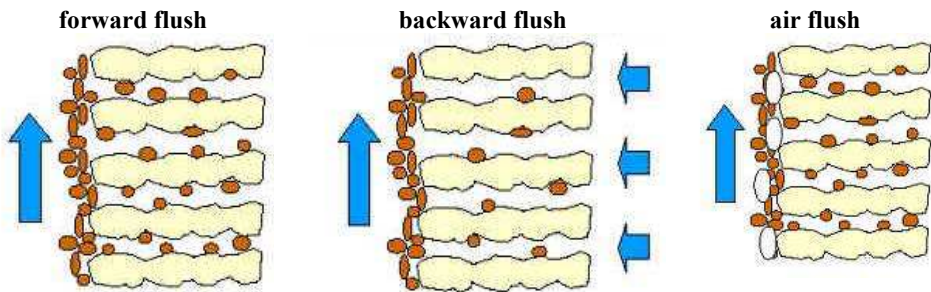

Fig. 7-7. The schema of hydraulic membrane cleaning methods

Backward flushing is a reversed filtration process. As presented in Fig. 7-8, the permeate is flushed through the feed water side of the system under pressure applying twice the flux that is used during filtration. The substances removed from the membrane surface are drained off. When the flux has not restored itself sufficiently after back flushing, a chemical cleaning process can be applied. A typical filtration cycle consists of filtration lasting for 15-50 minutes and 20 sec-2 min of backwashing. Permeate flux changes in systems with and without backflushing are presented in Fig. 7-9.

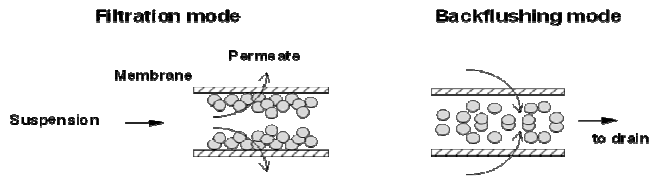

Fig. 7-8. Flows during filtration mode and backflushing

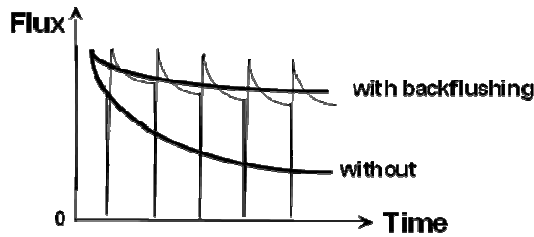

Fig. 7-9. Effect of backflushing on membrane permeation flux

Air flush or air/water flush is a forward flushing process during which air is injected in the supplier pipe. Because air is used while the water speed remains the same, a much more turbulent cleaning system is created [46].

During chemical cleaning, membranes are soaked with a specific cleaning solution. First, the solution soaks into the membranes for a number of minutes and then a forward flush or backward flush is applied causing the contaminants to be rinsed out. The frequency of chemical cleaning depends on the individual application and may be performed from once per week to once every few months. The choice of cleaning agent depends on the nature of substances causing the fouling as well as on the membrane properties. A summary of possible cleaning substances is given in Table 10.

Table 10. Possible membrane cleaning substances

| Cleaning chemical | Fouling material |
|--------------------------------------------------------------------------------------------------------------|-------------------------------------------------------------------|
| NaOCl | biological substances, natural organic matter, synthetic polymers |
| Acids (HCl, H ₂ SO ₄ , Citric Acid) | inorganic deposits |
| NaOH | natural organic matter |
| Sodium bi-sulfite (SBS) | reducible metals (Fe, Mn) |
| H ₂ O ₂ | natural organic matter |
| EDTA | metals |
| NaHSO ₃ /Na ₂ S ₂ O ₅ or NaOCl and H ₂ O ₂ | microorganisms |
| Alkaline detergents | natural organic matter |
| Enzymatic cleaning agents | Proteins |

7.3. Concentration polarization in electro dialysis

The phenomenon of concentration polarization is also very dangerous for ED process efficiency. It is an undesired phenomenon because it can completely stop the ED process. Fig. 7-10 presents an electro dialysis process with a cation-exchange membrane. On the right side of the membrane there is a diluate cell and on the left side of the membrane there is a concentrate cell. Near the membrane surface there is a boundary layer in which the ion concentrations vary from that in the bulk solution. On the diluate side the cation concentration is very low and on the concentrate side the cation concentration is high. Following an increase of electric current, a further decrease in the cation concentration on dialysate side and a further increase in the cation concentration on concentrate side can be observed. Finally, there will be a lack of ions in the diluate cell for current transport which is called concentration polarization. The current density at which the electric charge is still flowing is called the limiting current density.

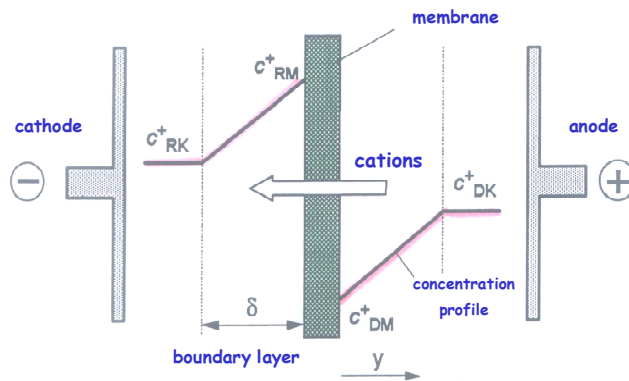

Fig. 7-10. Phenomenon of concentration polarization in the electrodesalination process (c_{RK}^+ – cation concentration in bulk solution in concentrate cell, c_{RM}^+ – cation concentration in boundary layer in concentrate cell, c_{DM}^+ – cation concentration in boundary layer in diluate cell, c_{DK}^+ – cation concentration in bulk solution in diluate cell) (based on [39])

The intensity of concentration polarization influences the value of the limiting current density. The effects and consequences of concentration polarization can be summarized as follows:

- decrease of ion concentration in the boundary layer (diluate cell),
- increase of ion concentration in the boundary layer (concentrate cell),
- further increase of current density causes an increase in concentration gradient, i.e. a decrease in the ion concentration in the diluate cell,
- increase of ED stack resistance and power demand,
- at the limiting current density the lack of ions for current transport and water dissociation,
- pH variations and possible membrane damage,
- precipitation of salts due to a high ion concentration in the boundary layer (in the concentrate cell),
- decrease of current efficiency.

8. MEMBRANE SYSTEM OPERATION

8.1. System operation modes

The operation of membrane systems can be performed in two different service modes:

- dead-end flow,
- cross-flow.

The concept of both systems is presented in Fig. 8-1.

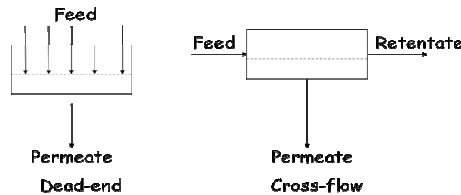

Fig. 8-1. Dead-end and cross-flow filtration

The dead-end flow mode of operation is similar to that of a cartridge filter where there is only a feed flow and filtrate flow. In this way, all of the feed is forced through the membrane which implies that the concentration of rejected components increases and the cake layer is formed on the membrane surface. As a result, the permeate flux and the quality of permeate decreases with time (Fig. 8-2). This concept is still used very frequently in microfiltration or in other processes when the aim of the membrane separation application is the concentration of substances from feed stream. The dead-end flow approach typically allows for optimal recovery of feed water in the range of 92 to 95%, but it is typically limited to feed streams with a low concentration of suspended solids (<1 NTU).

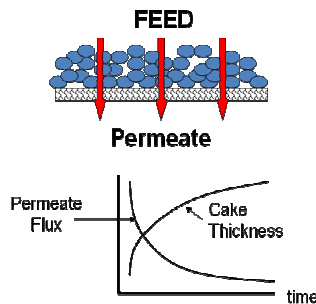

Fig. 8-2. Flux changes in dead-end mode

For industrial applications, cross-flow operation mode is preferred because of the lower fouling tendency. The cross-flow mode differs from the dead-end mode - in the former there is an additional flow aside from feed flow and filtrate flow (permeate), i.e., the concentrate flow. In cross-flow operation, the feed flows parallel to the membrane surface. The proper choice of cross-flow velocity and feed turbulence ensure a reduction in concentration polarization and fouling. As a result, the observed decrease in permeate flux is much lower compared to values in dead-end systems (Fig. 8-3). The cross-flow mode of operation typically results in the lower recovery of feed water, i.e. in the range of 80 to 90%.

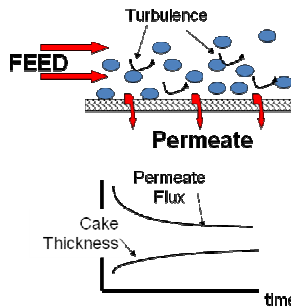

Fig. 8-3. Flux changes in cross-flow mode

Various cross-flow operations can be distinguished with the following presented in Fig. 8-4:

- co-current,
- counter-current,
- cross-flow with perfect mixing,
- perfect mixing.

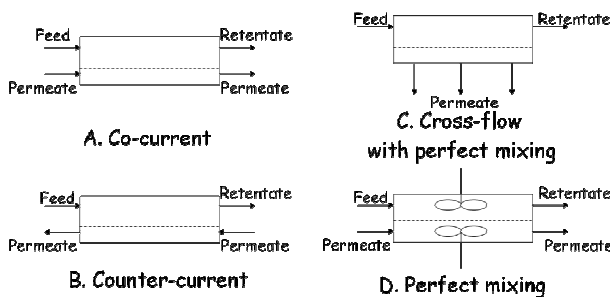

Fig. 8-4. Types of cross-flow operations

In co- and counter-current operations the feed and permeate streams flow parallel along the membrane surface. In this case, plug flow conditions appear. In cross-flow mode with perfect permeate mixing it is assumed that plug flow conditions occur on the feed side whereas mixing occurs on the permeate side. In practice, systems generally operate in the cross-flow mode with perfect permeate mixing.

8.2. Operating configurations

There are several operating configurations that are used in industrial practice depending on flow rate of the product, product characteristics and desired final concentrations of the product which is either to be retained by the membrane or recovered in the permeate.

For small-scale applications the batch system is used (Fig. 8-5). This system consists of a feed tank, membrane module and a feed pump, which also serves as a recirculation pump. The recirculation pump maintains the desired cross-flow velocity over a certain range of transmembrane pressure. The filtration continues until the final concentration or desired permeate recovery is achieved unless the flux drops to an unacceptable level.

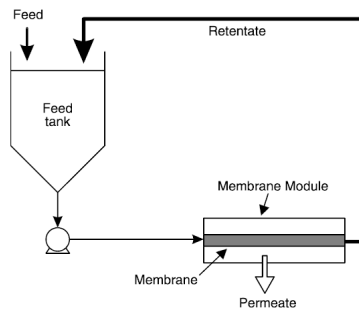

Fig. 8-5. Schematic diagram of a batch system

However, in the majority of environmental protection applications continuous single-pass or recirculation (feed and bleed) systems are used (Fig. 8-6).

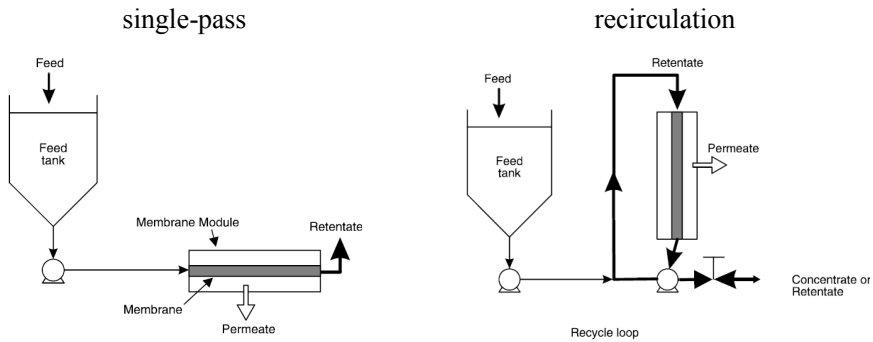

Fig. 8-6. Schematic drawing of a single-pass and recirculation systems

In the single-pass system the feed solution passes only once through the single membrane module, i.e. there is no recirculation. This system is not practical as it requires a large membrane area.

In the recirculation system a portion of the fresh solution is blended with the circulating stream. The quantity of feed equals the sum of permeate and retentate disposed out of the system. The recirculation system is much more flexible than the single-pass system and is preferred in cases where severe fouling occurs.

The single stage continuous configuration may not be economical for many applications since it operates with the highest concentration factor or lowest flux over most of the process duration. This is why membrane systems very often operate in multistage mode. Multistage continuous systems can approximate the flux obtained in true batch mode depending on the number of stages. The concentrate from each stage becomes the feed for the next stage. The number of stages required will depend on the final recovery or retentate concentration. Fig. 8-7 shows a schematic representation of a four-stage continuous system. The biggest advantage in using the multistage continuous configuration, especially in fermentation and biotechnology applications, is the minimization of residence time, which may be crucial in preventing the excessive bacterial growth of handled heat labile materials. One disadvantage with a multistage system is its high capital cost.

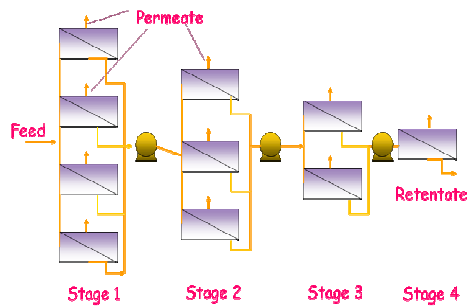

Fig. 8-7. Multistage membrane system

9. MEMBRANE MODULES

Industrial membrane systems often require hundreds or thousands of square meters of membranes to perform separation process. This amount of membranes should be packed into elements called membrane modules.

The membrane module is the unit into which the membrane area is packed and it should protect membranes against mechanical damage. In addition, the membrane module fits a large membrane area in a small volume.

Membrane modules should ensure

- high selectivity separation of components,
- high permeability with respect to solvent,
- high productivity of the process,
- leak tightness between the stream of permeate and retentate with a high ratio of membrane surface to module volume,
- facility of cleaning and sterilization,
- low costs,
- high membrane resistance against aggressive chemical, physical and biological factors,
- compactness of the system,
- possibility of membrane replacement.

There are 5 major types of modules normally used in membrane separation processes:

- plate-and-frame,
- spiral-wound,
- tubular,
- capillary,
- hollow fiber.

As presented in Fig. 9-1 plate-and-frame and spiral-wound modules are formed using flat sheet membranes, while tubular, capillary and hollow fiber module membranes have the shape of tubes of different diameters.

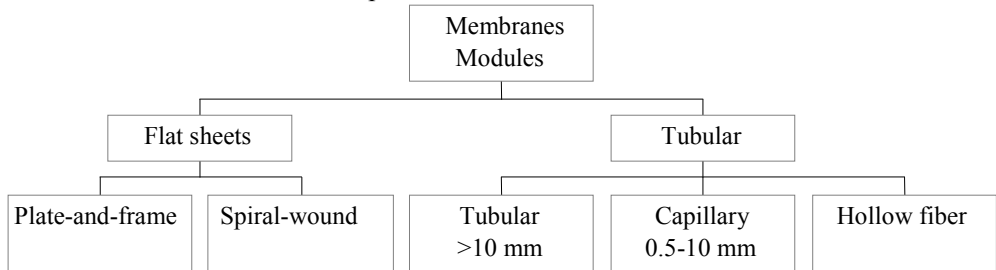

Fig. 9-1. Types of membrane modules

9.1. Plate-and-frame modules

Plate-and-frame modules were one of the earliest types of membrane systems. Membrane, feed spacers, and product spacers are layered together between two end plates. The schema of the plate-and-frame module is depicted in Fig. 9-2. The feed mixture is forced across the surface of the membrane with a portion passing through the membrane and entering the permeate channel (0.3-0.6 mm high). The recommended feed cross-flow velocity amounts to 2 m/s. This type of module is now only used in electrodialysis and pervaporation systems and in a limited number of reverse osmosis and ultrafiltration applications in which the feed has a high fouling tendency.

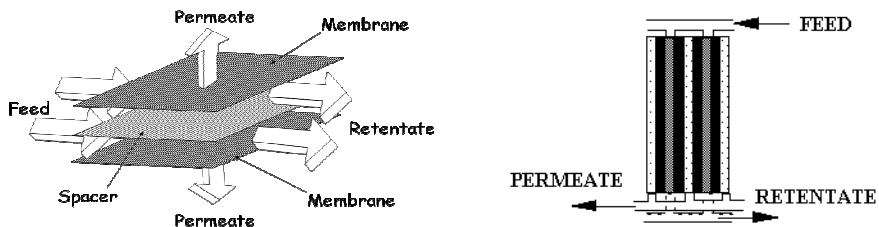

Fig. 9-2. The plate-and-frame module

The advantages of plate-and-frame modules are as follows:

- high allowable work pressure (suitable for high viscosity liquids),
- easy to clean,

- easy to replace membranes.

This type of module is characterized by a low membrane area per volume (100-400 m²/m³).

9.2. Spiral-wound module

Spiral-wound modules consist of a membrane envelope of spacers (up to 1 mm high) and membrane wound around a perforated central collection tube (Fig. 9-3). The feed flows axially through the cylindrical module parallel along the central pipe whereas the permeate flows radially toward the central pipe. A portion of the feed permeates into the membrane envelope where it spirals toward the center and exits through the collection tube. In this type of membrane module the recommended feed flow velocity amounts to 0.1-0.6 m/s.

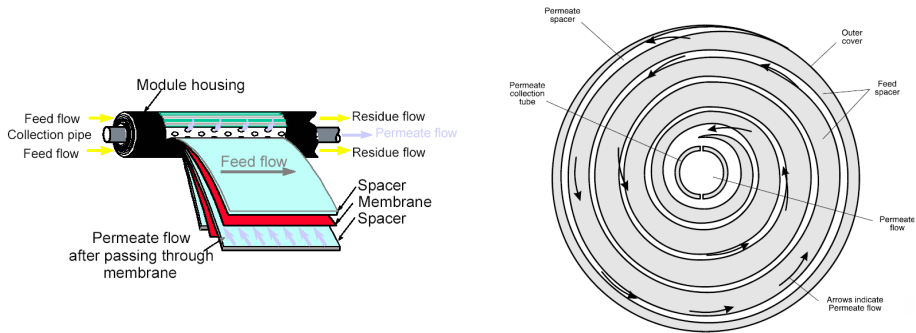

Fig. 9-3. Spiral-wound module (based on [19])

The spiral-wound module is placed inside a tubular pressure vessel. As presented in Fig. 9-4, a single pressure vessel contains 3-6 spiral-wound modules arranged in series.

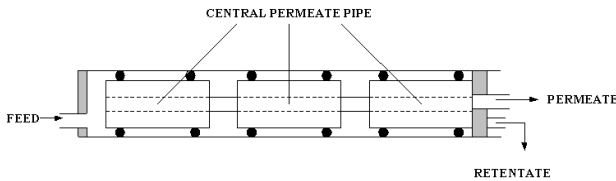

Fig. 9-4. Pressure vessel with spiral wound modules (based on [14])

Advantages of spiral-wound modules are as follows:

- high packing density ($300\text{-}1000\text{ m}^2/\text{m}^3$),
- easy and inexpensive to adjust hydromomics by changing feed spacer thickness to overcome concentration polarization and fouling,
- low relative costs.

Disadvantages can be summarized as

- difficulties in cleaning and sterilization,
- high pressure drop ($100\text{-}150\text{ kPa}$),
- may be used only for a pure medium.

9.3. Tubular module

Tubular modules consist of membranes formed inside tubes typically 6 to 25 mm in diameter and there are three basic types:

- self supporting tubular modules – consist of several membrane tubes held together as a pack and connected to common headers and permeate vessels. This type is limited by its structural strength to low-pressure applications;
- externally supported tubular membrane modules – consist of tubular membranes held inside individual porous support tubes. Several such tubes are assembled to common headers and permeate vessels to form a module. This type of tubular module can withstand high pressures;
- monolithic tubular modules – several tubular channels are formed in a porous block of material and a membrane layer is formed inside the tubes.

In tubular membranes the feed liquid flows inside the tube, and the permeate flows from the inside to the outside of the membrane tube (Fig. 9-5). The retentate is collected at the other end of the tubes. The recommended feed cross-flow velocity amounts to 2-6 m/s.

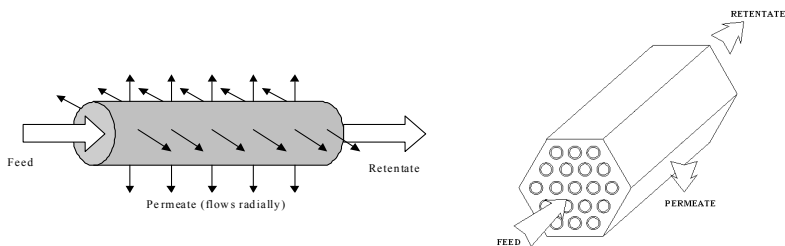

Fig. 9-5. Tubular membranes (based on [19])

The advantages of tubular modules are as follows:

- low fouling tendency (contamination can be minimized by the high feed flow rate),
- can operate with simple pre-treatment of feed liquid,
- easy cleaning,
- easy handling of suspended solids and viscous fluids,
- high transmembrane pressures.

Disadvantages can be summarized as follows:

- high capital cost,
- low packing density ($< 100 \text{ m}^2/\text{m}^3$),
- high pumping costs,
- limited by achievable concentrations.

9.4. Capillary and hollow fiber modules

The module concepts for capillary and hollow fiber modules are the same. The difference between them is simply the diameter of membrane tubes. These modules consist of a large number of capillaries assembled together in a module. The free ends of the capillaries are potted with agents such as epoxy resins and polyurethanes (Fig. 9-6).

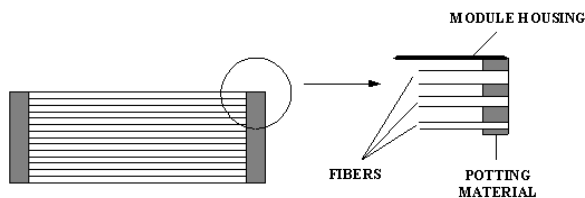

Fig. 9-6. Capillary module

Two types of pressure driven capillary or hollow fiber membranes are available (Fig. 9-7):

- inside-out membranes where the influent is fed inside the membrane lumen and the clean water travels from the inside of the membrane to the outside. In this case, the recommended feed cross-flow velocity amounts to 0.5-2.5 m/s;
- outside-in membranes where the influent is fed from the outside of the membrane and the clean water travels from the outside to the inside (lumen) of the membrane.

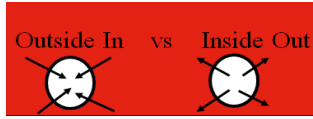

Fig. 9-7. Capillary module arrangement

The choice between the two concepts is mainly based on the application where the parameters such a pressure, pressure drop, type of membrane available etc. are important. Depending on the concept chosen, asymmetric capillaries are used with their skin on the outside or inside.

It is advantageous to use the ‘inside-out’ type to avoid an increase in permeate pressure within the fibers. Also, for this type the thin selective top-layer is better protected. On the other hand, a higher membrane area can be achieved with the ‘outside-in’ concept. Inside-out mode is a pressure driven filtration process and requires pressure vessels. Outside-in mode is a suction driven filtration process and the membranes are submerged in a tank containing the feed solution.

Table 11 summarizes certain properties of membrane modules while Table 12 presents module application possibilities for different membrane processes.

Table 11. Characteristics of membrane modules

| | TUBULAR | PLATE & FRAME | SPIRAL WOUND | CAPILLARY | HOLLOW FIBER |
|-----------------------------------------------------|----------------|--------------------------|---------------------|------------------|---------------------|
| packing density, m²/m³ | < 300 | 100 - 400 | 300 - 1000 | 600 - 1200 | up to 30000 |
| manufacturing costs, \$/m² | 50 - 200 | 100 - 300 | 30 - 100 | 20 - 100 | 2 - 20 |
| resistance to fouling | very good | good | moderate | good | very poor |
| parasitic pressure drops | low | moderate | moderate | moderate | high |
| membrane replacement | yes/no | yes | no | no | no |

Table 12. Application of membrane modules in particular membrane processes

| | Tubular | Plate-frame | Spiral wound | Capillary | Hollow fiber |
|----------|---------|-------------|--------------|-----------|--------------|
| MF | ++ | + | | + | |
| UF | ++ | + | + | ++ | |
| NF | ++ | + | ++ | ++ | + |
| RO | + | + | ++ | + | ++ |
| Gas sep. | | | ++ | + | ++ |
| PV/VP | ++ | ++ | + | + | |
| ED | | ++ | | | |

10. APPLICATION OF MEMBRANE PROCESSES IN ENVIRONMENTAL PROTECTION

Since the development of synthetic asymmetric membranes in 1960, interest in membrane processes for water and wastewater treatment has steadily grown. These technologies are now the subject of substantial research, development, commercial activity and full-scale application. The relatively global increase in the use of membranes in environmental engineering applications is caused by three categories of factors: 1) increased regulatory pressure to provide better treatment for both potable and wastewater, 2) increased demand for water and thus the exploitation of water resources of poor quality, 3) market forces surrounding the commercialization of membrane technologies [11].

Membrane processes can play a key role in reducing water scarcity. They can be used to treat wastewater prior to discharge to surface water, to recovery valuable substances from industrial effluents and to treat water for potable use.

10.1. Water

The world's water consumption rate is doubling every 20 years, outpacing by two times rate of population growth. It is projected that by the year 2025 water demand will exceed the supply by 56% due to persistent regional droughts and the water needed for industrial growth [47]. The supply of freshwater is decreasing while water demand for food, industry and people is rising.

The possible areas of membrane process application in water treatment are as follows:

- water desalination,
- treatment and desalination of mine water,
- water softening,
- water demineralization and production of ultra-pure water,
- treatment of natural water for drinking water production:

- removal of nitrates,
- removal of micropollutants.

10.1.1. Water desalination

Water covers 70.9% of the Earth's surface, however, it is found mostly in the oceans. Fig. 10-1 presents the distribution of water on and in the Earth. The left-side bar shows where the water on Earth exists - about 97% of all water is in the oceans. The middle bar shows the distribution of the three percent of Earth's water that is freshwater. The majority, about 69%, is locked up in glaciers and icecaps. It is surprising that of the remaining freshwater, almost all of it is groundwater. Of all the freshwater on Earth, only about 0.3% is contained in rivers and lakes.

It can be concluded that over 99% of all water (oceans, seas, ice, most saline water and atmospheric water) is not available for human use. Furthermore, much of the remaining fraction of one percent (Fig. 10-2) is out of reach. Considering that most of the water which is used in everyday life comes from rivers, it can be seen that generally only a tiny portion of the available water supplies is used. The bottom pie in Fig. 10-2 shows that the vast majority of the freshwater available for human use is stored in the ground.

Desalination is defined as the removal of dissolved salts from various waters: brackish, sea, etc. The concentration of dissolved ions in water can vary to a large extent. The following water classification system as regards to salt concentration is used:

- freshwater: less than 1,000 mg/dm³,
- brackish waters:
 - slightly saline water - from 1,000 to 3,000 mg/dm³,
 - moderately saline water - from 3,000 to 10,000 mg/dm³,
 - highly saline water - from 10,000 to 35,000 mg/dm³,
- sea (ocean) water: more than 35,000 mg/dm³ of salt.

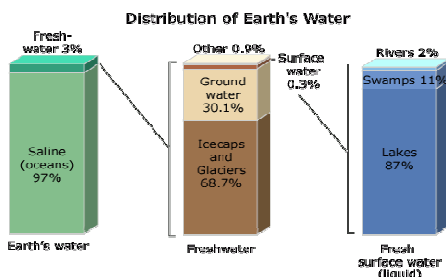

Fig. 10-1. Water on Earth [47]

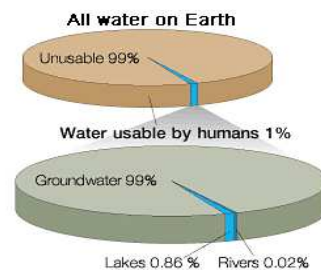

Fig. 10-2. Availability of water for humans [47]

The main constituents of seawater are chlorides and sodium ions. Seawater also contains minor amounts of sulfates, calcium, potassium and magnesium. As seen from Table 13, the highest salt concentration can be found in the seas of the Middle East. In addition, the Aral Sea is characterized by very high salinity, but this is due to very intensive water evaporation and environmental degradation. Although the Baltic Sea is called a “sea”, it is characterized by very low salt content.

Table 13. Salinity of seawaters

| Sea | Salt content, mg/dm ³ |
|-------------------|----------------------------------|
| Baltic Sea | 7,000 |
| Mediterranean Sea | 38,000 |
| Red Sea | 41,000 |
| Persian Gulf | 45,000 |
| Aral Sea | 45,000 (to 100,000) |

There are many unit processes which can be applied to water desalination. The classification of desalination processes is as follows:

- separation as the result of phase change:
 - thermal processes (MSF, MED, VC),
 - freezing out,
- separation with the use of membranes:
 - reverse osmosis,
 - electrodialysis,
 - electrodialysis reversal,
 - membrane distillation,
 - piezodialysis,
 - ion exchange.

Desalination is widely utilized globally and is very common in water scarce areas such as the Middle East. Among all these methods, thermal processes, reverse osmosis and electrodialysis are the most commonly applied technologies in large desalination plants.

Thermal technologies involve the heating of saline water and collecting the condensed vapor (distillate) to produce pure water. Thermal technologies have rarely been used for brackish water desalination because of the high cost involved. They have, however, been used for seawater desalination.

Multi-stage flash evaporation (MSF) is distillation through several (multi-stage) chambers. The feed water is first heated under high pressure and is brought into the first “flash chamber” where the pressure is released causing the water to

suddenly evaporate. The generated vapor is condensed into fresh water on heat exchange tubing and then run through each stage.

Multi-effect distillation MED occurs in a series of vessels (effects) and uses the principle of evaporation and condensation at reduced ambient pressures. Transport of heat to the first vessel is necessary. A series of evaporator effects produce water at progressively lower pressures. Water boils at lower temperatures as pressure decreases and thus the water vapor of the first vessel serves as the heating medium for the second, and so on.

Vapor compression VC differs from MED and MSF technology in that it uses a compressor to produce enough heat to evaporate pure water from a saline solution. The feed water should be pre-heated and the generated vapor (after compression) is condensed by contact with cool saline water.

Desalination methods can also be classified as follows:

- as regards change of the state of aggregation:
 - with no change of the state of aggregation (RO, ED),
 - with a change in the state of aggregation (distillation, freezing out),
- with respect to type of energy:
 - heat energy – distillation,
 - electrical energy – ED,
 - mechanical energy – RO,
- as regards type of separation:
 - processes in which water is separated from solution – distillation and RO,
 - processes in which salt is separated from solution – ED and ion exchange.

Desalination is the process of removing dissolved salts from saline or brackish water to make it fit for human consumption and other domestic purposes or for agricultural and industrial use. In the case of complete salt removal, the process is called demineralization. Feed water should be subjected to pre-treatment prior to entering the desalination installation (Fig. 10-3). Pre-treatment can be very simple or complex depending on the water quality and type of desalination method. To perform desalination it is necessary to supply energy – thermal, electric or mechanical. Post-treatment is generally performed when purified water is directed to the water-supply system.

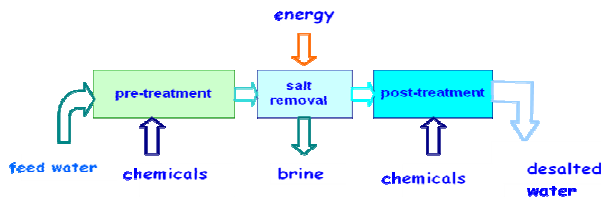

Fig. 10-3. Principle of the desalination process

The advantages of membrane processes in comparison to thermal desalination processes are as follows:

- operating at ambient temperatures,
- energy demand amounting to 30-50% of the energy demand in thermal processes,
- less usage of high-quality materials (thermal and corrosion resistance),
- lack of corrosion problems,
- lack of air pollution,
- flexibility in treated water quality and installation capacity:
 - desired water quality can be reached by applying suitable membranes or adding stages (passes),
 - desired capacity can be reached by adding membrane modules.

Desalination technologies were introduced about 50 years ago and were able to expand access to water, but at high cost. Developments of new and improved technologies have now significantly broadened opportunities to access major quantities of safe water in many parts of the world. Presently, more than 150,000 desalination plants are in operation producing more than 30 million of cubic meters of water per day. It is estimated that the capacity of all planned, in construction and operating desalination installations amount to 55 million m³/day. The capacity of seawater desalination plants is equal to almost 4 million m³/day. It is also anticipated that the total desalination capacity will reach almost nearly 95 million m³/day by 2015 [48].

Most desalination plants were built in the Middle East and in North America. Significantly less capacity has been installed in Europe and Asia. Taking into account the number of desalination installations, it can be stated that the US is the leader in this area – mainly due to their many small membrane plants (Figs. 10-4a,b). Taking into account the number of distillation plants and the capacity of seawater desalination plants, there is no doubt that the countries of the Middle East are the unquestionable leader in this field (Figs. 10-4c,d).

It is apparent that seawater and brackish water are the main sources of feed water for desalination installations; however, it is worth noting that even wastewater can be desalted in order to produce useful water. Fig. 10-5 presents salt concentration ranges for various desalination processes. It is very important to take into account the water salinity for a given method because there is a strong correlation between salt content and energy demand. It is assumed that ion exchange methods are suitable for very low salt concentrations (up to 1 g/dm^3), electro dialysis is applied to brackish water and reverse osmosis is suitable for seawater desalination. Thermal techniques can be used for the desalination of seawater and brines.

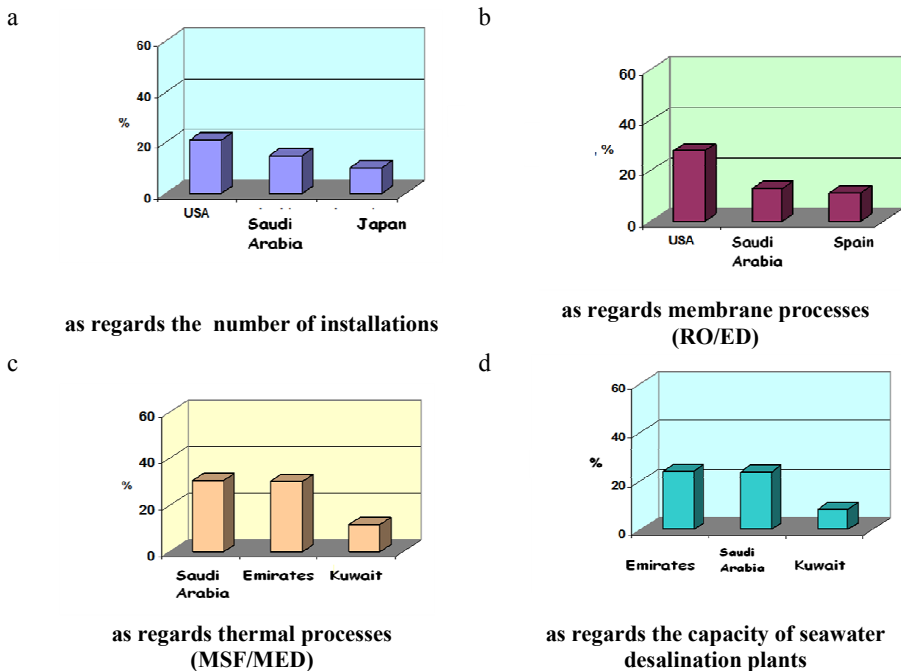

Fig. 10-4. World leaders in water desalination

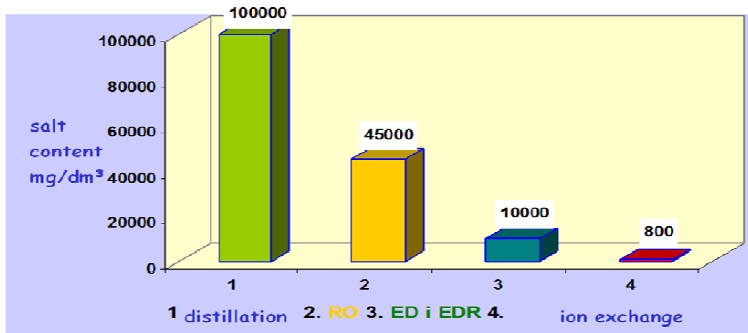

Fig. 10-5. Preferable salt concentration for desalination by various methods

Power demand is an essential parameter because when the energy demand is rather low, the probability that a given method will be widely utilized is rather high. The development of new and improved technologies for energy recovery has caused a significant decrease of power demand in reverse osmosis – to about 2.5 kWh/m³. Evaporation-distillation methods are characterized by a high power consumption as is electro dialysis when applied to seawater desalination (Fig. 10-6).

As can be seen from Table 14, with improvements in technology desalination processes are becoming cost-competitive with other methods of producing usable water for our growing needs. The unit cost of seawater desalination by reverse osmosis is equal to 0.7-0.8 \$/m³ and with energy recovery it can even reach 0.45 \$/m³. The unit desalination costs in the case of thermal processes are somewhat higher. The development of cheaper and more effective membranes, improved energy efficient systems and other technological advancements have allowed the cost of seawater desalination by reverse osmosis to decline significantly – from 1.3 \$/m³ in 1995 at Bahama Island to 0.42 \$/m³ in 2005 at the Singapore desalination plant.

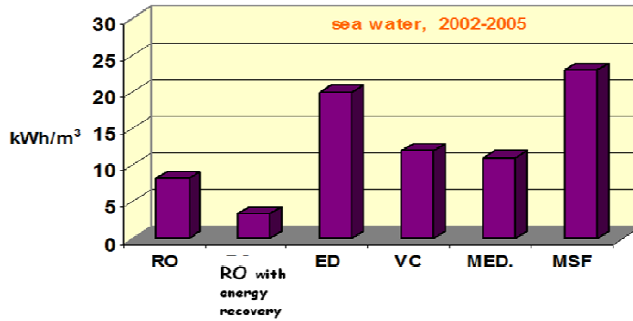

Fig. 10-6. Power demand in desalination processes

Table 14. Costs of seawater desalination

| cost | method | MSF | MED | VC | RO |
|-----------------------------------|--------|-----------|-----------|-----------|----------------------|
| investment, \$/m ³ day | | 1200-1500 | 900-1000 | 950-1000 | 700-900 |
| total, \$/m ³ | | 1.10-1.25 | 0.75-0.85 | 0.87-0.95 | 0.68-0.82 (0.45)* |

* with energy recovery

In summary, the parameters influencing desalination costs are as follows:

- type, capacity and localization of the installation,
- source, quality and temperature of raw water,
- required degree of desalination,
- extent of required pre-treatment,
- desired quality of desalted water and the possibility of permeate blending with feed water,
- storage and post-treatment of purified water,
- material and operating costs,
- labor operating costs,
- costs of chemicals and energy,
- costs of concentrate disposal,
- membrane exchange costs.

A RO desalination plant essentially consists of four major systems: pretreatment system, high-pressure pumps, membrane systems and post-treatment

(Fig. 10-7). Pre-treatment is very important in RO because the membrane surface must remain clean. High pressure pumps supply the pressure needed to enable the water to pass through the membrane and have the salt rejected. The pressures vary from 2-3 MPa for brackish water to 6-8 MPa for seawater.

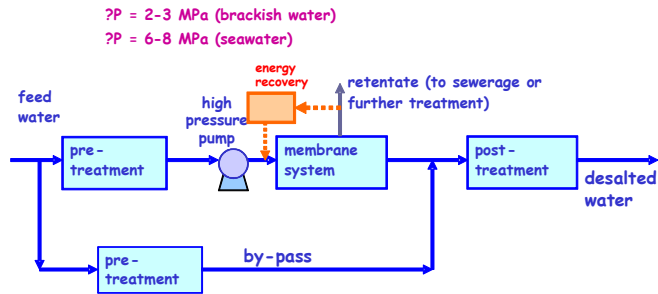

Fig. 10-7. General scheme of a RO desalination installation

The membrane assembly consists of a pressure vessel and semi-permeable membranes that permit the feed to pass through. RO membranes for desalination generally come in two types: spiral wound and hollow fiber. Spiral wound elements are constructed from flat sheet membranes. Membrane materials may be made of cellulose acetate or polyamide or of other composite polymers. Another type of membrane is the hollow fiber, but this type of design is currently not as widely used for desalination as the spiral wound membranes.

Post-treatment consists of stabilizing the water and preparing it for distribution.

It is now common to use energy recovery devices connected to the concentrate stream as it leaves the pressure vessels at about 0.5 MPa less than the applied pressure from the high pressure pump. The energy recovery devices are mechanical and consist of turbines, pressure exchangers or other devices that rotate and produce energy thus assisting the RO process in reducing the overall energy needs. The energy recovered can be as high as 30-40% of the input energy for seawater.

Generally, RO desalination installations consist of many stages, especially when seawater is being desalinated. The purpose of such designs is to improve the quality of permeate. The water, after pre-treatment, enters the MF unit and then is pressurized to pass the membrane modules in the first stage. The received permeate can be directed through a high-pressure pump to the second stage. The retentate

from the first stage is discharged or it can be subjected to energy recovery. The retentate from the second stage can be recycled and blended with the feed water.

A three-stage RO desalination installation is very useful when the maximum degree of feed water concentration is needed. The permeates from the three stages are mixed together giving potable water. It should be pointed out that retentate from the first stage is the feed for the second stage and the retentate from the second stage is the feed for the third stage; thus these streams contain increasing salt content. Because of this, the quality of permeate worsens with each subsequent stage. The total water recovery is equal to 90%.

For the correct design of a RO desalination installation the water composition should be known in great detail. The concentration of all ionic compounds should be given (calcium magnesium, sodium, potassium, barium, strontium, iron, manganese, nitrates, carbonates, sulfates, chlorides, etc.) as well as some other parameters such as silica, pH, alkalinity suspended solids, dissolved solids, temperature, hydrogen sulfite, turbidity, organic carbon, bacteria content and silt density index (SDI). The SDI parameter is an important parameter in membrane processes providing information about the fouling potential. It is recommended that the SDI should not be higher than 3. In the case that it is greater than 3, the feed water should be pre-treated.

Water quality is a crucial parameter influencing the following design parameters of RO installations:

- investment costs,
- operating costs,
- maximum recovery,
- quality of water produced,
- possibility of permeate mixing with raw water (in order to reduce the overall cost of the process),
- membrane type,
- number of stages,
- retentate management.

It is apparent that with increasing water salinity the overall RO cost increases, whereas the possible recovery decreases and the quality of permeate also decreases. When the feed water contains a high amount of salts, it is necessary to apply expensive membranes and to add additional stages. In this situation, brine management can also be a major problem.

In practice, most of the water pollutants can have a negative effect on membrane operation. These harmful substances can be categorized as

- destructive (bases, acids, chlorine, bacteria),
- pore and surface clogging:

- scaling (sulfates, carbonates, fluorides, silica),
- fouling (metal oxides, colloids, microorganisms, bacteria).

In order to ensure efficient membrane operation, it is necessary to apply reliable water pre-treatment steps. During pretreatment, all suspended solids must be removed and the pretreatment should ensure that salt precipitation and microbial growth does not occur on the membrane. Pre-treatment may involve conventional methods such as coagulation, flocculation, sedimentation and sand filtration. Pre-treatment can also use membrane processes such as microfiltration and ultrafiltration. The choice of a particular pre-treatment process is based on a number of factors such as feed water quality characteristics, space availability, RO membrane requirements, etc.

Possible water treatment systems can be as follows:

- surface water:
 - chlorination - coagulation - sedimentation – sand filtration - MF;
- water of high hardness:
 - softening - sand filtration - MF;
- water of low hardness:
 - sand filtration – MF.

It should be pointed out that chlorination at the initial stage of water treatment is not recommended due to possibility of forming chlorinated organic compounds.

The main purpose of water pre-treatment is to prevent membranes and the membrane installation from mechanical clogging as well as to prevent fouling and scaling. Suspended solids are removed in filtration and microfiltration. Colloids and metal oxides can be removed by applying coagulation with ferric or aluminum compounds. Improved coagulation can be achieved by applying coagulation with the aid of flocculation by polyelectrolytes, sedimentation and filtration. Substances which may cause biological fouling such as microorganisms and their metabolic products can be rendered harmless by the chlorination of water and subsequent dechlorination by dosing sodium sulfite or sodium hyposulfite. Adding biocides such as sodium bisulfite, formaldehyde or copper sulfate to treated water can help in killing living organisms. Organic substances (e.g. solvents) can be effectively removed by adsorption on activated carbon.

High concentrations of mineral salts are very dangerous due to their scaling potential. To prevent scaling, i.e. to prevent the formation of carbonate and sulfate sludge (CaCO_3 , CaSO_4 , BaSO_4 , SrSO_4) and the precipitation of SiO_2 , the following procedures should be applied:

- dosing acid into feed water (calcium carbonate CaCO_3 will not be precipitated, emission of CO_2 will occur),

- dosing scaling inhibitors which delay crystal formation, e.g. sodium hexametaphosphate (sulfates will not be precipitated – calcium sulfate- CaSO_4 , barium sulfate - BaSO_4 , strontium sulfate - SrSO_4),
- increasing the water temperature,
- keeping the pH > 8 or < 6 will prevent silica precipitation,
- decreasing the water recovery,
- water softening using ion exchange methods,
- water softening by lime or by lime and soda (calcium and magnesium hydroxides will be precipitated).

Generally, the produced water will be used as drinking or process water. Post-treatment involves

- removal of dissolved gases (carbon dioxide CO_2 and hydrogen sulfide H_2S) in vacuum degasified or sprinkling cascade bed,
- pH adjustment in order to prevent corrosion (by caustic soda or by burnt lime),
- disinfection of desalted water by chlorine or chlorine dioxide.

If the desalinated water is being combined with another source of water, it is very important to ensure similar water quality characteristics in both water sources.

Concentrate is generated as a side product of the separation of minerals from the source water used for desalination. Therefore, this liquid stream contains most of the minerals and contaminants and pretreatment additives in concentrated form. The concentration of minerals and contaminants in the concentrate is usually 2 to 10 times higher than that in the source water. The possible methods of concentrate disposal can be as follows:

- discharge directly to surface waters (e.g. river, lake, sea),
- discharge to sanitary sewer,
- deep well injection or discharge to underground excavations,
- evaporation ponds,
- spray irrigation (only for concentrates of low TDS),
- zero liquid discharge (evaporation of water and concentration of salt).

Key environmental issues associated with concentrate disposal to surface waters include

- salinity increase beyond the tolerance thresholds of the species in the area of discharge,
- concentration of metals and radioactive ions to harmful levels,
- concentration and discharge of nutrients which can change the marine flora metabolism,
- disturbance in the ion-balance of receiving waters,

- disturbance of bottom marine flora and fauna during outfall installation.

The salt concentration in RO concentrate amounts to 1,500-25,000 mg/dm³ after brackish water desalination and 65,000-85,000 mg/dm³ after seawater desalination.

Fig. 10-8 shows a flow diagram of a typical RO desalination plant for drinking water production. At the beginning, the feed water is subjected to coagulation and flocculation. Then the pre-treated water is pumped through a sand filtration bed and adsorption columns to a MF unit. After removing all suspended solids, colloids and metal oxides the water can be directed to RO modules using a high-pressure pump. Desalted water should be disinfected and the pH adjusted. The resulting concentrate is discharged to the sewer or surface water. In order to prevent scaling, some scaling inhibitors and acid are added prior to the membrane installation.

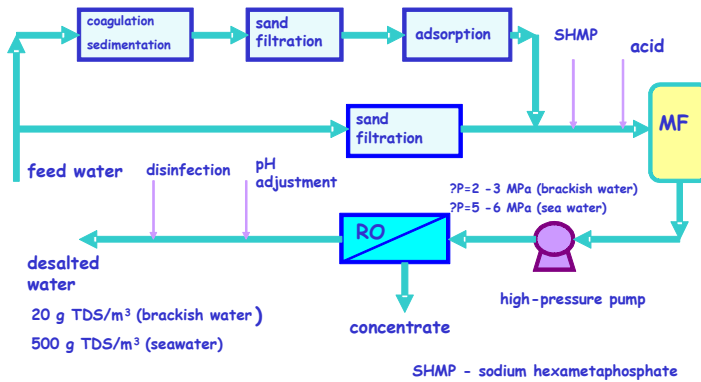

Fig. 10-8. Schematic of a typical RO desalination system for drinking water production (based on [49])

Fig. 10-9 illustrates a RO desalination plant with UF as a pre-treatment step. The flow pattern is similar to that previously described. The feed water is also subjected to conventional pre-treatment including coagulation, flocculation and sand filtration. Then the water enters the UF modules instead of adsorption columns.

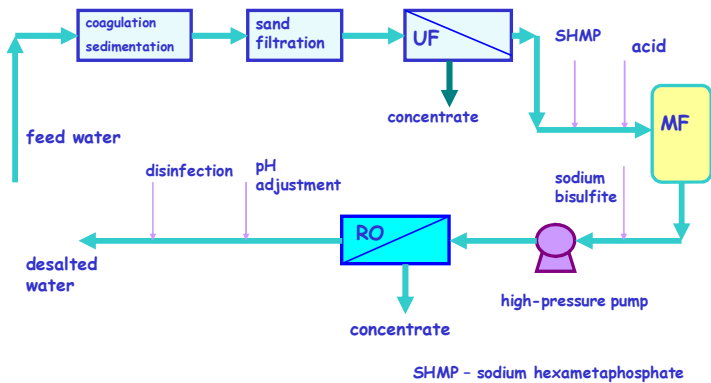

Fig. 10-9. Schematic of a RO desalination system with UF pre-treatment for drinking water production(based on [49])

Although it may seem that introducing a second membrane process will increase the investment cost, the advantages of UF as a pre-treatment step are clear due to

- lower operating costs,
- lower frequency of RO membrane cleaning,
- decrease in RO membrane exchange costs (by 20%),
- pre-treatment can be simplified and cheaper by 10%.

The application of UF after the filtration of seawater containing 39 g TDS/dm³ enables [49]

- decrease of turbidity to a level lower than 0.16 NTU,
- decrease of DOC to a value less than 0.7 mg/dm³,
- decrease of the suspended solid concentration to a level lower than 15 mg/dm³,
- decrease of the SDI to 2.8-3.3 from the initial value of 5.5-6.2,
- decrease of the bacterial concentration to 1-2/100 ml from the initial concentration of 50-60/100 ml for raw water.

One of the largest desalination plants is located in Ashkelon, Israel (Fig. 10-10). From the intake pumping station, raw seawater is sent for pre-treatment consisting of dual-media gravity filters with chemicals added prior to filtration. The use of ferric chloride as a coagulant facilitates a good reduction of the SDI. Filtration is performed through gravity filters containing quartz sand and anthracite media. The low filtration rate (8 m/h) allows for a high filtration efficiency even with storm turbidity levels. A set of Micronics filters forms a final safety barrier

before the membranes. The desalination system consists of four stages. This unusual configuration is due to the high permeate quality requirements with chloride less than 20 mg/dm^3 and boron less than 0.4 mg/dm^3 . The first pass operates at 45% recovery while the second pass operates at 85% recovery with an elevated pH to increase boron removal efficiency. The third pass is fed by concentrate from the second pass and the recovery in this pass amounts to 85%. The fourth pass, operated at 90% recovery and at a high pH, completes the boron removal from the second pass brine. In total, the plant makes use of 25,500 Filmtec seawater type membranes and 15,100 brackish water type membranes. Post treatment with lime is applied to remineralize the product water. The adjustment of pH and alkalinity are necessary before distribution. The plant has a capacity of $330,000 \text{ m}^3/\text{day}$ and the water cost is calculated as $0.5 \text{ \$/m}^3$.

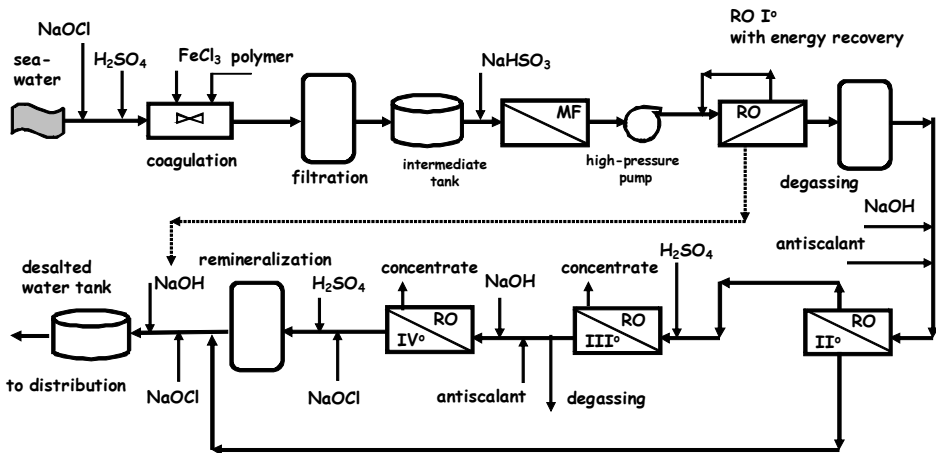

Fig. 10-10. Ashkelon desalination plant (based on [50])

The most recent desalination plant was built in 2010 in Sydney. This plant provides up to 15% of Sydney's drinking water supplies having a capacity of $250,000 \text{ m}^3/\text{day}$. Seawater is delivered from the ocean through a 2.5 km long tunnel on the ocean floor and enters the plant through screens which filter out material larger than 5 mm. Pre-treatment involves coagulation by ferric chloride and gravity filtration through sand and coal filters. Filtered seawater is pumped with a pressure of 5-6 MPa into the reverse osmosis installation consisting of 36,000 membranes. The retentate is directed to the energy recovery device (DWEER) before being returned to the ocean via the outlet tunnel. The two-stage RO system operates at 42% recovery. Fluoride and lime are added to the product water to meet Australian

Drinking Water Guidelines. Remineralized water is then disinfected by adding chlorine and ammonia.

Although the main source of water for desalination process is seawater or brackish water, there are also possibilities and needs for wastewater desalination. Fig. 10-11 presents a very good example of municipal secondary effluent treatment by membrane process – reverse osmosis. The main purpose of such treatment is to protect groundwater from seawater infiltration. The plant is located in California and it has been operating since 1975. The purified wastewater, after mixing with groundwater is injected into the ground to replenish the existing resources. Then the injected water can be withdrawn as drinking water.

According to the scheme in Fig. 10-11, the technological process consists of coagulation with lime, flocculation and clarification. In order to decrease the water pH, recarbonation by dosing CO₂ is applied. Then part of the pre-treated wastewater enters the adsorption unit with the second part flowing through the RO modules. Finally, the purified effluents are mixed with groundwater and injected into the ground.

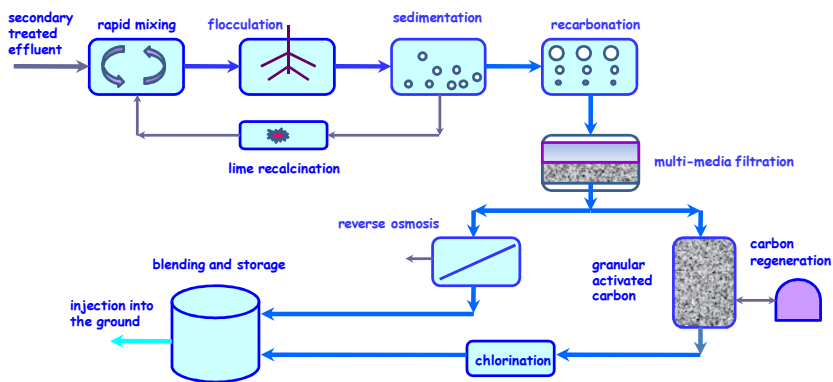

Fig. 10-11. Schematic of wastewater desalination in Water factory 21 (California, USA) (based on [51])

10.1.2. Treatment of mine waters

Historically, mine waters were considered a lost resource. However, the scarcity of freshwater has resulted in mine waters being used as a viable industrial and potable water resource. Besides being a possible resource, mine waters can

have a serious impact on the environment. The consequences of untreated or poorly treated mine water discharge to surface waters are as follows:

- destruction of fauna and flora,
- worsening of river water quality which makes the water unsuitable for municipal and agricultural purposes,
- required additional treatment of river water for industrial purposes,
- the need for an expensive water supply from other regions.

Due to the intensive exploitation of coal beds in Poland in the past and also in the present, mine water utilization has become an important task. For example, in 2000, 32 mines discharged water to the Vistula River while 36 mines discharged water to the Oder River resulting in 150 million and 55 million cubic meters of saline water per year, respectively [50].

Mine water can be classified according to the chloride and sulfate concentration as follows:

- I group: drinking water
 $\text{Cl}^- + \text{SO}_4^{2-} < 0.6 \text{ kg/m}^3$;
- II group: industrial water
 $\text{Cl}^- + \text{SO}_4^{2-} = 0.6 - 1.8 \text{ kg/m}^3$;
- III group: moderately saline water
 $\text{Cl}^- + \text{SO}_4^{2-} = 1.8 - 42 \text{ kg/m}^3$;
- IV group: brines
 $\text{Cl}^- + \text{SO}_4^{2-} > 42 \text{ kg/m}^3$.

Only 20% of mine waters in Poland contain about 600-800 mg of salt per dm^3 (acceptable level for drinking water) and can be used as potable water following minimal treatment. Mine waters of the II and partly of the III group can be a potential source of water for municipal and industrial use, but these waters require more advanced treatment. Special treatment methods should be applied to the IV group (salinity $> 200 \text{ g/dm}^3$).

The reduction of mine water discharge to surface waters can be achieved by

- the application of treatment technologies which enable water and salt recovery and their economic reuse, e.g. as drinking water,
- mining and geological activity:
 - deep injection into the ground which is the cheapest and the safest method of disposal,
 - storage of mine water concentrates in underground excavations,
 - closing of mines or drawing levels.

The most effective available treatment methods are

- reverse osmosis,
- nanofiltration,
- evaporation,

- integrated systems.

Membrane processes can be applied as an alternative or together with conventional desalination methods in the form of integrated systems.

Low saline mine waters (from the II group) are used as a source of drinking water in the following coal-mines in Poland:

- “Pokój” (Ruda Śląska),
- “Rydułtowy”,
- “Piast”.

Fig. 10-12 presents the flow diagram of mine water treatment by RO in the coal-mine “Pokój”. The mine water is taken from the depth of 450 m and is subjected to the following processes: coagulation-flocculation, pressure filtration, microfiltration 25 μm and 5 μm , two-stage RO and degassing. In order to prevent sulfate precipitation on the membrane surface, the antiscalant SHMP (sodium hexametaphosphate) is added to the stream before the membrane installation. Due to the very good quality of permeate that is much better than drinking water standards, about 8-10% of the pre-treated mine water is mixed with the RO product. The installation produces 800 m^3/day of drinking water with 50% recovery at a total water cost of 0.41 $\$/\text{m}^3$ [52].

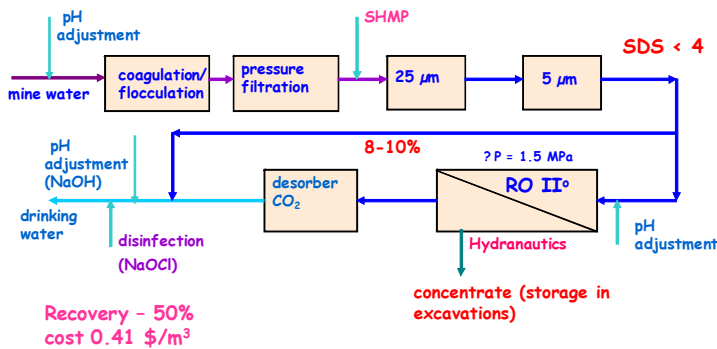

Fig. 10-12. Flow diagram of mine water desalination by RO in the coal-mine “Pokój” (based on [52])

10.1.3. Water demineralization

Industry uses large volumes of water (Table 15) and much of the water should meet potable quality standards or even requires further treatment to reduce the content of mineral and organic substances. The quality of water used for industry

varies considerably from one industry to another. Treated water is frequently used in the following industries: power generation, food and beverage application, pharmaceutical production, metal finishing and microelectronics manufacturing. Taking into account such parameters as conductivity, total dissolved solids (TDS), hardness, alkalinity, silica, etc. the following water types can be distinguished: softened, dealkalized, deionized, purified, apyrogenic, high purity, and ultrapure (Table 16).

Table 15. Water demand of various industrial sectors [53]

| Industry | Water demand |
|----------|------------------------------------------------------------------------|
| Paper | 29 m ³ /t paper produced |
| Brewing | 10-15 m ³ /m ³ beer |
| Dairy | 140 m ³ /m ³ milk |
| Sugar | 8 m ³ /t sugar |
| Textile | 100 m ³ /t fabric processed |
| Power | 3 m ³ /MWh for steam, 60 m ³ /MWh for cooling |

Table 16. Industrial water quality standards [53]

| Parameter | Water | | | | | | |
|-----------------------------------------------|----------|-------------|-----------|----------|------------|-------------|-----------|
| | softened | dealkalized | deionized | purified | apyrogenic | high purity | ultrapure |
| Conductivity, $\mu\text{S}/\text{cm}$ | | | 20 | 5 | 5 | 0.1 | 0.06 |
| Resistivity, $\text{M}\Omega \cdot \text{cm}$ | | | 0.05 | 0.2 | 0.2 | 10 | 18 |
| TDS, mg/dm^3 | | | 10 | 1 | 1 | 0.5 | 0.005 |
| pH | | | 5-9.5 | 6-8.5 | 6-8.5 | 6.5-7.5 | |
| LSI ¹ | -1 - +1 | -1 - +1 | | | | | |
| Hardness, $\text{mg CaCO}_3/\text{dm}^3$ | 20 | | 0.1 | 0.1 | 0.1 | | 0.001 |
| Alkalinity, $\text{mg CaCO}_3/\text{dm}^3$ | | 30 | | | | | |
| Silica, mg/dm^3 | | | 0.5 | 0.1 | 0.1 | 0.01 | 0.002 |
| SDI ² | | | 5 | 3 | 3 | 1 | 0.5 |
| Bacteria, CFU/ml | | | | 10 | 1 | 1 | 1 |
| Pyrogens, EU/ml | | | | | 0.25 | | 0.25 |

¹Langelier index ²silt density index

Water demineralization by ion exchange is a common unit operation in industrial water production, especially for boiler feed water. Ion exchange processes fall into one of several categories: softening, dealkalization and demineralization. By applying both cation and anion exchangers it is possible to remove ionic constituents which may cause scaling in a steam generator. Depending on the water source, the water is pretreated to reduce the suspended solids, colloids and total dissolved solids (TDS) load to the ion exchange unit. Methods of pretreatment include coagulation and filtration, adsorption and decarbonization with lime (Fig. 10-13).

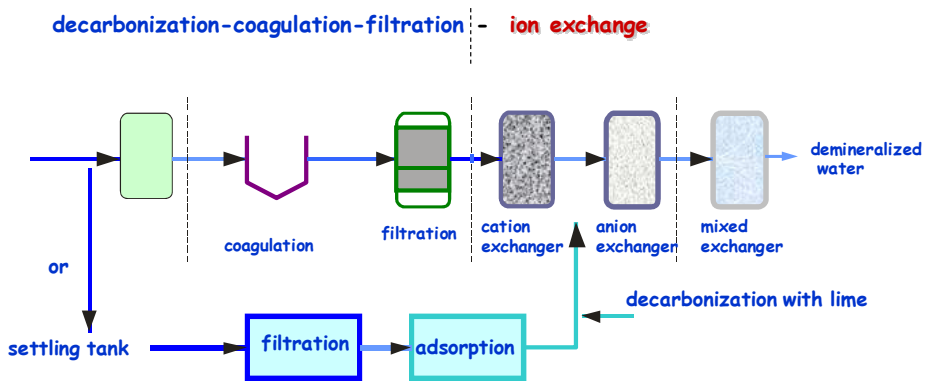

Fig. 10-13. Conventional water demineralization technology (based on [52])

Although ion exchange itself does not directly consume energy, there are several problems with using this unit process alone which involve

- short operating cycles of ion exchangers due to the quick exhaustion of ion exchange capacity,
- high amounts of post-regeneration wastewater,
- difficulties in producing high quality water,
- potential for unacceptable levels (peaks) of contamination in effluent.

These factors are likely to contribute to an increase in pollution in the environment as well as to high operating costs for water demineralization. These disadvantages can be overcome by applying the following membrane processes in pure water production:

- reverse osmosis,
- microfiltration,
- ultrafiltration,
- electro dialysis,
- electro dialysis reversal,

- electrodeionization .

In many cases, more than one unit process is employed to achieve the final desired quality. The most common advanced separation systems are as follows:

- integrated system: reverse osmosis – ion exchange or electrodeionization,
- integrated system: electrodialysis – ion exchange,
- multi-stage reverse osmosis,
- with microfiltration or ultrafiltration
 - as a pre-treatment process before demineralization,
 - as a post-treatment of deionized water,
- tri-membrane system.

Generally, reverse osmosis (or electrodialysis) prior to ion exchange (Fig. 10-14) reduces the content of total dissolved solids in the feed water, thus bringing about a large reduction in the ion exchanger load. The advantages of applying reverse osmosis as a pre-demineralization step before ion exchange can be summarized as follows:

- ion exchangers operate at better conditions producing high quality water,
 - the duration of the operation cycle of ion beds is extended,
 - the number of bed regenerations is reduced and as a consequence the usage of chemicals is also reduced,
 - the physical stability of ion exchangers is improved,
 - there is no secondary pollution of purified water,
 - UV disinfection of water is more efficient,
 - the installation capacity increases, whereas overall dimensions decrease,
- very often only a mixed ion exchange bed (instead of a two-bed system consisting of a cation exchanger and an anion exchanger) is sufficient to produce demineralized water.

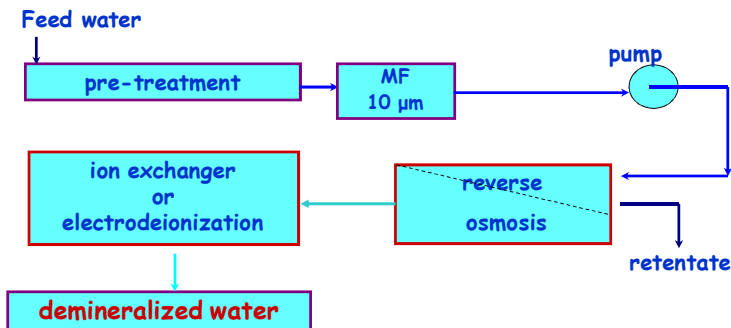

Fig. 10-14. Integrated system – reverse osmosis-ion exchange (based on [52])

An integrated system consisting of reverse osmosis and electrodeionization is another method of water demineralization producing product of excellent quality (see chapter 6.4.3). Such a system is applied in the Heat and Power Generating Plant EC Wrotków/Lublin (Poland) (Fig. 10-15) to produce water for steam turbines. The feed water is taken from a nearby lake and after pre-chlorination is directed to accelerators where decarbonization by lime milk occurs. The successive treatment steps involve multilayer filtration, filtration through an activated carbon layer, softening by the Upcore system, microfiltration through a 5 µm filter, two-stage reverse osmosis and electrodeionization. The quality parameters of the feed, RO permeate and product water are given in Table 17.

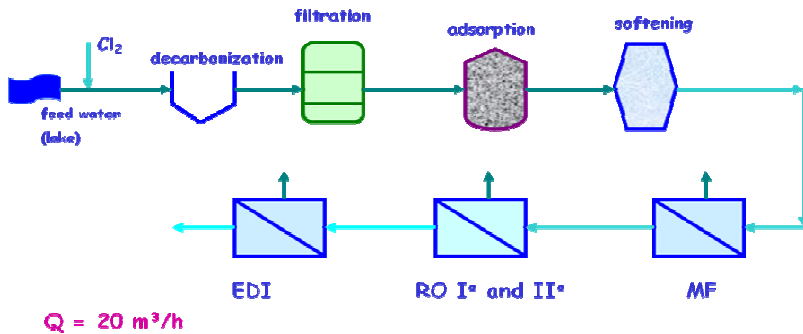

Fig. 10-15. Production of ultra-pure water in an integrated system: RO-EDI (Heat and Power Generating Plant EC Wrotków/Lublin) (based on [54])

Table 17. Water analysis in an integrated system RO-EDI (Heat and Power Generating Plant EC Wrotkow/Lublin) [54]

| Parameter | Feed water | RO permeate | Water after EDI |
|------------------------------------|------------|-------------|-----------------|
| Conductivity, µS/cm | 499 | 8.2 | 0.06 |
| Chlorides, mg/dm ³ | 14.2 | 0.04 | < 0.03 |
| Sulfates, mg/dm ³ | 24.9 | 0.1 | < 0.1 |
| Silica, mg/dm ³ | 24.1 | 0.055 | < 0.006 |
| Organic carbon, mg/dm ³ | 9.0 | < 0.2 | < 0.2 |
| Ba, mg/dm ³ | 0.055 | 0 | 0 |
| Ca, mg/dm ³ | 91.3 | 0.007 | 0 |
| Mg, mg/dm ³ | 5.7 | 0.001 | 0.003 |
| Na, mg/dm ³ | 6.0 | 0.69 | 0.002 |

The second integrated system of water demineralization consists of electro dialysis reversal (EDR) followed by ion-exchange (Fig. 10-16). In the Power Plant Gulf Coast (Texas, USA), with the Brazos River as the source, plant water is pretreated and demineralized to feed two 8.75 MPa waste heat recovery units at up to a maximum flow of 14,500 m³/day. River water pre-treatment consists of chlorination, lime-softening clarification using a polymer and coagulant followed by multi-media filtration. The pretreated river water is then roughly demineralized in an electro dialysis reversal membrane system with further demineralization by ion-exchange. The ion-exchange system consists of cation and anion-exchange resin beds followed by mixed-bed polishing [55].

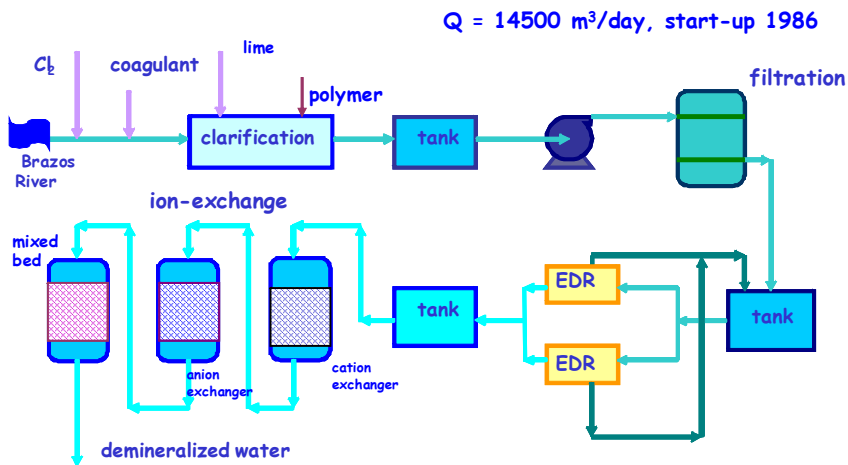

Fig. 10-16. Water demineralization in an integrated system EDR-IE in Power Plant Gulf Coast (Texas, USA) (based on [55])

The application of EDR as a pre-treatment step before ion-exchange brings about the following benefits:

- the number of bed regenerations is reduced,
- the usage of chemicals is reduced,
- the amount of post-regeneration wastewater is reduced,
- the physical stability of ion exchangers is improved,
- the overall costs are reduced.

A two-stage RO membrane system can also be useful in water demineralization. In this system, the same membrane type can be applied in both stages or the membrane material may differ. The main disadvantage of such a multi-stage RO arrangement is its sensitivity to feed water pollution. The value of the SDI (silt density index) for raw water should be lower than 5. The two-stage RO treatment system is successfully used in the Heat and Power Generating Plant EC Żerań (Warsaw, Poland) (Fig. 10-17). Due to the poor quality of the feed water from the Vistula River, pre-treatment is very extensive. It involves successive unit processes: chlorination by chlorine dioxide, decarbonization by calcium hydroxide, coagulation by ferric sulfate aided with polyelectrolyte and filtration on gravel and anthracite-sand filters. Between the filtration stages a disinfecting agent as well as coagulant and flocculant are added to the treated water. The polishing step before RO includes adsorption and microfiltration with a 5 μm membrane filter. The two-stage RO system has a capacity of 700 m³/h and consists of more than 1000 Filmtec spiral wound modules placed in 168 pressure vessels. The plant operates at 75% recovery under a pressure of 1.6 MPa. The treatment effects are shown in Table 18.

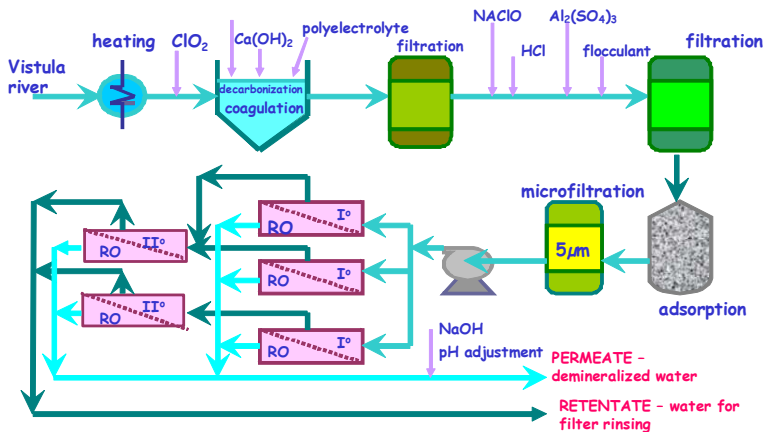

Fig. 10-17. Water demineralization installation at the Heat and Power Generating Plant EC Żerań (based on [52])

Table 18. Treatment effects for the water demineralization plant at the Heat and Power Generating Plant EC Żerań [52]

| Treatment step | pH | Conductivity, $\mu\text{S/cm}$ | Hardness, mg/dm^3 | Oxygen demand, mg/dm^3 | SiO_2 , mg/dm^3 | Turbidity, NTU | SDI |
|------------------------------------------|-----|--------------------------------|----------------------------|---------------------------------|-----------------------------------|----------------|-----|
| Vistula River | 7.6 | 640 | 250 | 9.8 | 8.2 | - | - |
| After decarbonization and coagulation | 9.8 | 500 | 125 | 4.3 | 1.9 | 2.2 | 4.0 |
| After filtration and dosing of chemicals | 6.8 | 510 | 113 | 1.6 | 1.6 | - | 1.8 |
| After adsorption | 6.7 | 512 | 110 | 1.1 | 1.5 | 0.02 | 1.6 |
| Permeate | 4.9 | 13.7 | 0.15 | 1.0 | 0.05 | - | 0.2 |

Low-pressure membrane processes such as microfiltration and ultrafiltration can also be applied in water demineralization: 1) as a preliminary step prior to water deionization by ion exchange or reverse osmosis or 2) as a post-treatment step of deionized water (Fig. 10-18). Proper pretreatment of the stream prior to the membrane or ion-exchange system is critical because pretreatment increases the lifetime of membranes or resins. In some ion-exchange installations, demineralization is followed by a final filtration (MF or UF) step to reduce the content of colloidal silica. For example, the silica concentration in boiler feed water should be less than 0.01 mg/dm^3 , but ion-exchangers remove only ionic silica, whereas colloidal silica can be eliminated by UF/MF membranes.

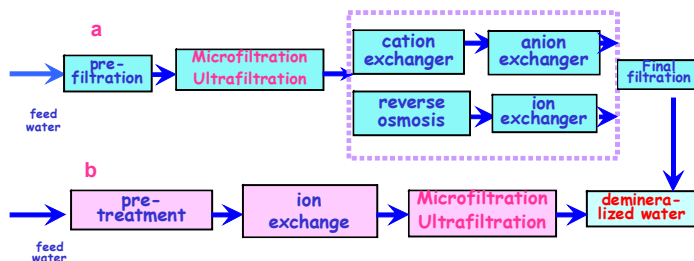

Fig. 10-18. Application of MF/UF in water demineralization: a) as pre-treatment, b) as post-treatment (based on [52])

The most extended integrated configuration in water demineralization consists of ultrafiltration, electrodialysis reversal, reverse osmosis and ion exchange (UF-EDR-RO-IX). This system is used in a nuclear power station due to the high quality product – ultrapure water with a conductivity approximately less than 0.06 $\mu\text{S}/\text{cm}$. The Braidwood Nuclear Station (Fig. 10-19) is a two-unit, 2350 MW plant located south of Chicago supplied by the Kankakee River. The demineralizer has a designed capacity of 700 m^3/day . River water pre-treatment consists of a polymer feed and lime softening clarification followed by sand and activated carbon filtration. The water is further treated and demineralized in a multimembrane trailer which includes UF, EDR and RO. The RO permeate is then fed to an ion-exchange demineralizing system consisting of cation and anion-resin beds followed by a mixed-bed polisher.

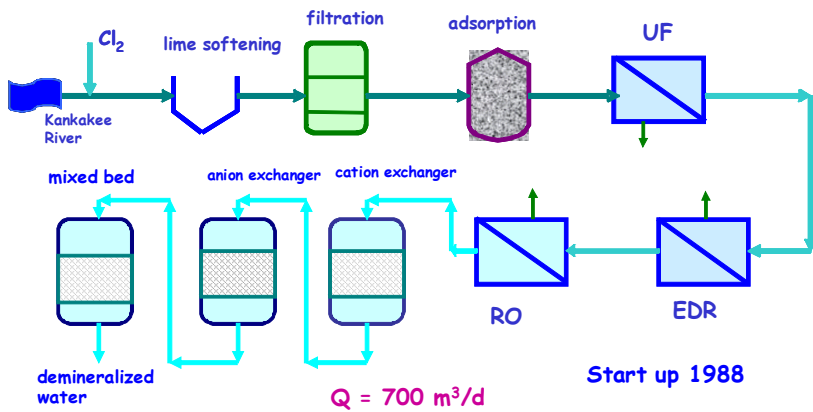

Fig. 10-19. Integrated system – UF-EDR-RO-IE in the Nuclear Power Plant Braidwood/Chicago (USA) (based on [55])

10.1.4. Drinking water production by natural water treatment

Conventional water treatment plants supplying drinking water involve several unit processes in various combinations (Fig. 10-20). The specific combination of selected unit processes depends on the quality of raw water. In the case of clean, unpolluted water disinfection is sufficient to meet the microbiological quality requirements. In contrast, water containing solutes, colloids and particulates may require many unit processes (oxidation, coagulation, sedimentation, filtration, adsorption, and disinfection) to achieve the required drinking water standards. In traditional water treatment processes the use of coagulants and flocculants is

necessary to destabilize and agglomerate colloids. As a consequence, these chemicals are present in the generated sludge thus creating a large disposal problem. Moreover, the treated water may also contain residual coagulants if the coagulation is not correctly controlled or operated.

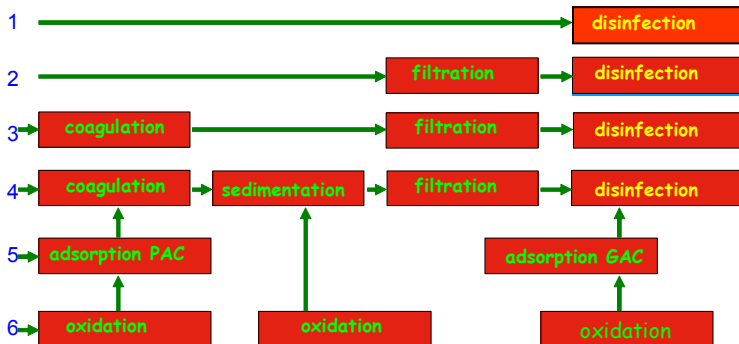

Fig. 10-20. Conventional natural water treatment technology (GAC – granular activated carbon, PAC – powdered activated carbon) (based on [56])

Membrane technologies are receiving special recognition as alternatives to conventional water treatment in that they can often overcome the limitations of conventional methods. In principle, correctly selected membranes are able to eliminate all water pollutants without using chemicals.

The pressure membrane processes are the most suitable in drinking water production:

- microfiltration (MF) can be used in water clarification,
- ultrafiltration (UF) rejects suspended solids and provides an absolute barrier for all microorganisms; thus it can be used in water clarification and disinfection,
- nanofiltration (NF) removes all colloids, small organic substances and bivalent salts; thus it can be used for removing color and softening and sometimes for removing micropollutants [57, 58],
- reverse osmosis (RO) removes monovalent ions and most small organic substances; thus it is applied in water desalination and micropollutant removal.

New membrane technologies feature the use of low pressure systems that significantly reduce energy as well as operation and maintenance costs. One of the key issues in membrane applications is the possibility for the removal of disinfection by-products such as trihalomethanes (THMs) and haloacetic acids

(HAAs) as well as the elimination of illness-causing microorganisms such as *Giardia* and *Cryptosporidium*.

Due to the improvements made in membrane technology and the implementation of new water quality requirements that exceed the capabilities of existing treatment processes, membranes are now cost-competitive alternatives for many treatment applications.

A major area of membrane development for municipal drinking water supplies is desalination (see Chapter 10.1.1). Electrodialysis (ED) and reverse osmosis (RO) compete with thermal processes such as multistage flat evaporation (MSF) or multiple effect distillation (MED). Nanofiltration is the second largest process in water treatment for softening and the removal of disinfection by-product precursors. The advantages of nanofiltration as a method of water softening are as follows:

- smaller footprint (smaller volume of devices),
- lack of sludge (huge amounts of sludge are generated during chemical softening),
- less demand for chlorine (disinfection) due to a lower content of organic compounds in the permeate,
- stability of operation independent of variations in feed water quality,
- flexibility in installation capacity,
- better quality of purified water,
- better removal of organic and mineral substances,
- removal of bacteria and viruses,
- simplicity of maintenance.

Although there is great potential for membrane processes in replacing conventional water treatment methods, it has been found that integrated systems are the most efficient in drinking water production. Such systems consist of traditional unit processes (coagulation, filtration, adsorption) and a single or a set of membrane installations. Pre-treatment is required to remove excessive suspended solids and other constituents that would foul the membrane surface. This pretreatment is usually made by conventional methods. Among the membrane techniques, the most commonly used process for the production of drinking water is RO, but NF is now emerging as a viable alternative to conventional water treatment because it can operate at lower pressures and higher recovery rates than RO systems. NF is also cost-effective in many groundwater softening applications where the incoming turbidity is low.

The Méry-sur-Oise Water Treatment Plant (WTP) (France) uses nanofiltration (NF) as a final barrier in treating surface water (Fig. 10-21). This plant has been in operation since 1999 and has a capacity of 140,000 m³/day. The source water (Oise

River) is characterized by great fluctuations in organic content, suspended solids concentration and pesticide concentration. Extended pre-treatment includes coagulation, flocculation and settling in a ACTIFLO settler, ozonation, filtration through a two-layer sand and anthracite bed preceded by a second injection of coagulant and followed by microfiltration. Coagulation is carried out using polyaluminum chloride (PAX) and an anionic polyelectrolyte. This specific pretreatment sequence minimizes the SDI of feed water entering the NF modules. The NF installation with Filmtec spiral wound membranes operates at 1 MPa with an 85% conversion rate. Post-treatment consists of removing excess CO₂, using degassing towers, UV disinfection and pH adjustment. The quality of the product water meets all drinking water standards – the pesticide concentration was reduced from 1 µg/dm³ (in the raw water) to 0.1 µg/dm³, whereas the TOC value was lowered from 10 mg/dm³ to 0.7 mg/dm³. The water taste also improved due to a reduced chlorine demand.

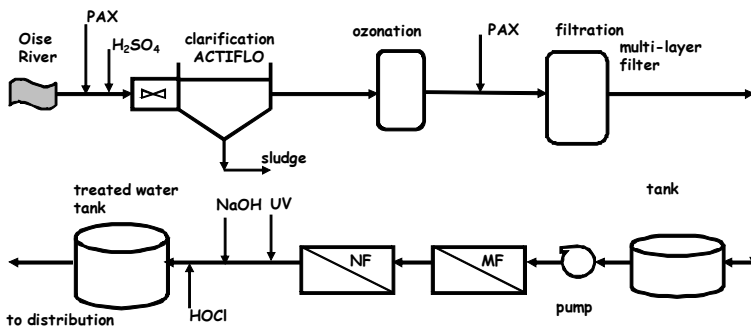

Fig. 10-21. Process flow diagram for the Méry-sur-Oise WTP (based on [59])

Sometimes the integration of conventional treatment methods with low-pressure membrane processes (MF/UF) is sufficient to produce potable water. Low-pressure membrane processes are often integrated with coagulation [60-63], activated carbon adsorption or ion exchange [64-67]. The main advantage of UF/MF processes lies in removing *Giardia* and *Cryptosporidium* from natural water.

The Bexar Met WTP (Texas, USA) uses UF to treat surface water (Fig.10-22). The plant has been in operation since 2000 and the main driver of applying UF was the presence of protozoa *Cryptosporidium* in the source water (Medina River). Water in the Medina River can have high turbidity (above 2,000 NTU), but overall has a low TOC (below 3 mg/dm³). Traditional treatment involves preliminary

sedimentation, coagulation by ferric chloride and sedimentation with the use of superpulser clarifier. For improved removal of micropollutants, PAC is added *in-line* to the treated water twice. The Aquasource UF membrane modules operating in dead-end mode have been applied and the turbidity of permeate was lowered to the value of 0.01-0.06 NTU.

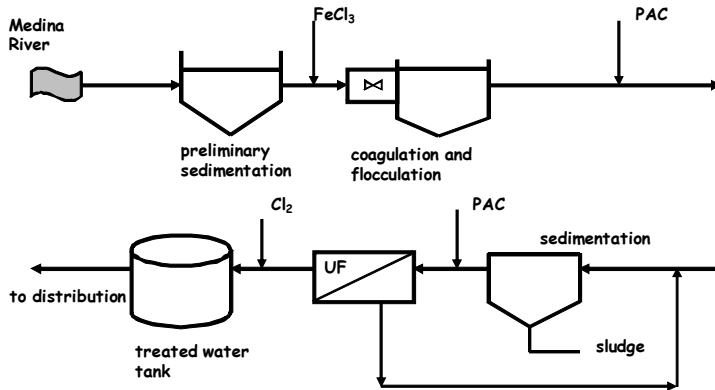

Fig. 10-22. Process flow diagram for the Baxer Met WTP (based on [68])

10.2. Wastewater

10.2.1. Treatment of oil emulsions

The treatment of oil emulsion wastewater is of crucial importance because this type of effluent is harmful to sewage systems as well as to the environment. When oil emulsion wastewater is discharged to sewage system it can

- disturb mechanical and biological treatment,
- cause an adverse effect on sewerage.

When oil emulsion wastewater is discharged to surface waters it can

- make water treatment difficult,
- limit the water usability for municipal needs and recreation.

Oil content in emulsion wastewater amounted to a few dozen kg/m^3 (1-10%).

Oil emulsions are used in the machine-building industry, in the metallurgical industry and in the iron and steel industry to

- cool the treated devices and elements,
- decrease friction between metal elements,
- prevent treated elements from sticking together,
- prevent corrosion.

Oil emulsions contain oils (mineral, vegetable, synthetic), fatty acids, emulsifiers (anionic, nonionic surfactants), corrosion inhibitors and biocides.

Ultrafiltration can be used in oil emulsion effluent treatment. The feed stream is divided into two streams (Fig. 10-23):

- permeate without oil ($< 10 \text{ mg/dm}^3$) containing mineral and small-molecular weight organic compounds (corrosion inhibitors, emulsifiers, antifoaming agents),
- retentate (concentrate) of oil emulsion containing 30-70% of oil.

The received permeate can be directed to further treatment by RO, adsorption or biological degradation. Retentate can be concentrated to 5-10% of the initial volume of wastewater and then can be subjected to further concentration by centrifugation and finally combustion.

Prior to proper treatment, the used oil emulsions should be pre-treated. The pre-treatment of oil emulsions includes mixing, removal of non-emulsified oils by drift fender and removal of solid impurities by filtering and centrifuging. Then a portion of the pre-treated exhausted oil emulsion is directed to the UF modules. The process is carried out as a batch system, i.e. with retentate recirculation to receive the desired degree of concentration. Regeneration of membrane modules is necessary after each batch.

There are many variations of UF/MF membrane systems in oil emulsion treatment:

- ultrafiltration, permeate subjected to further treatment in a wastewater treatment plant,
- ultrafiltration with permeate reuse in the technological process,
- combination of micro- and ultrafiltration with permeate recirculation to the technological process. In the MF process, oil emulsion effluent having a 1% concentration is pre-concentrated to 10%. This concentrate is directed to the UF installation where further concentration occurs. Permeates from both MF and UF are mixed and reused in the technological process.

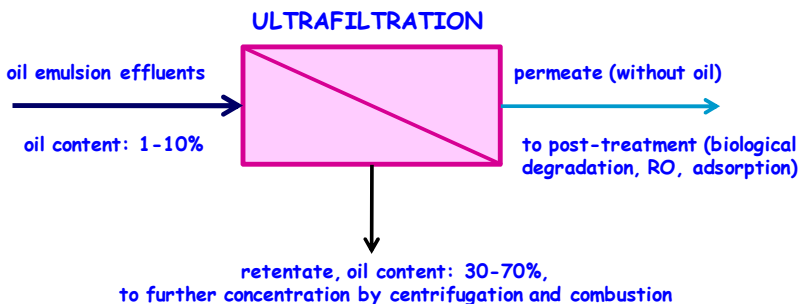

Fig. 10-23. Principle of oil emulsion effluent treatment by ultrafiltration

10.2.2. Regeneration of electrophoretic painting baths

Electrophoretic painting involves using charged paint particles. The cleaned metal parts to be coated are immersed in a tank of electrodeposition paint and the current is activated so that the charged paint particles are deposited on a metal surface. Usually, the electrophoretic painting bath contains a suspension of charged resin particles, pigments, surfactants, stabilizers and organic solvents.

The UF process is directly applied to treat the exhausted electrophoretic painting bath thus enabling

- retention of colloidal particles of paint,
- removal of excess solvent and “alien” ions from the exhausted painting bath,
- water recovery.

During ultrafiltration of the electrophoretic painting bath the retentate is recirculated to the coating bath to keep a constant concentration of paint, whereas permeate is directed to the rinsing line thus decreasing the water demand. In this system, it is possible to recover 98% of the paint. The direct ultrafiltration of painting bath enables its complete regeneration.

The advantages of UF in the electrophoretic painting of metal elements are as following:

- decrease of painting costs,
- maximum usage of paints,
- improvement in the quality of painted elements,
- decrease of pollution load.

10.2.3. Water and chemical reuse in the textile industry

Effluents from the textile industry contain dyes, acids, bases, salts, surfactants, sizing agents and wetting agents. Due to the many impurities and various chemical properties, conventional treatment methods such as chemical precipitation, activated sludge, chlorination, ozonation and adsorption on activated carbon are insufficient in reducing the pollution load in textile wastewater. The presence of dye compounds, which are hardly degradable and toxic, makes biological treatment very difficult [69, 70].

Membrane processes can be applied in textile effluent treatment as the following:

- UF in the treatment of effluents containing macroparticles (sizing agents, latex compounds) [71]
- UF in the treatment of effluents from wool and cotton scouring [72],
- NF/RO in the treatment of dye-house effluents [73, 74]. .

The benefits of applying membrane processes include the following:

- recovery of valuable substances – up to 90%,

- recovery and reuse of water in technological lines,
- power recovery (due to the recovery of warm water) - up to 60%,
- possibility of water closed loops,
- decrease of generated wastewaters [75-77].

The application of membrane processes in technological lines and effluent treatment in the textile industry enables using closed loops. In conventional pollution treatment systems unusable wastes are generated, whereas in membrane pollution treatment systems most of the chemicals and water can be reused (Fig.10-24). In such systems only an insignificant replenishment of water, energy and chemicals is necessary. The value of recovered substances can be as high as 2400 \$/day at a plant with a capacity of 7800 m³/day.

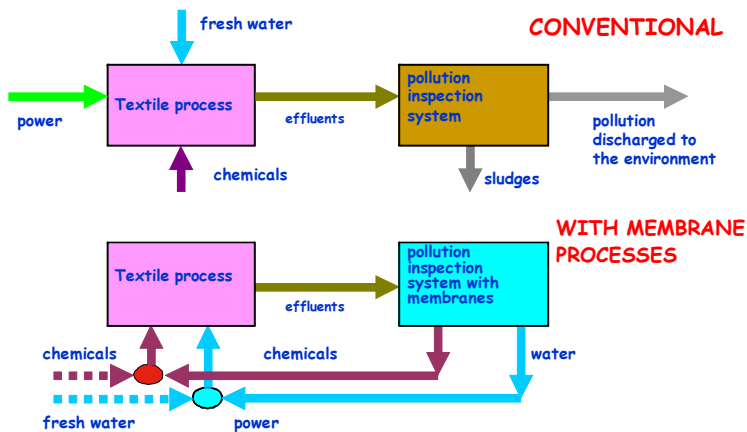

Fig. 10-24. Pollution treatment systems in the textile industry (based on [49])

Table 19 lists some valuable recoverable compounds from various textile processes. The textile industry uses synthetic sizing agents such as polyvinyl alcohol, polyacrylate and carboxymethyl cellulose. These sizing agents must be washed out after weaving. Due to their nonbiodegradability and high cost, these sizing agents should be recovered by ultrafiltration. Raw wool must be treated with hot water containing sodium carbonate, salts and nonionic detergents. In the ultrafiltration of wool scouring effluent, the permeate containing some of the detergent is of good enough quality to be recycled to the scouring tank.

Effluents arising from the dyeing operation can be treated and nearly 100% reused. Effluents from dyeing contain salts, bases, unfixed dyes (colloidal and dissolved), fatty acids, surfactants and other organic substances (degreasing

substances, emulsified oils and fats, oxidizing and reducing agents). Treatment of these effluents can be performed in order to decrease their color intensity, to remove organic substances or to recover water, dyes and mineral salts.

Large amounts of hot water are used in the dyeing of textiles and fibers. Energy demand in dye-houses is equal to 80% of the total power demand in the textile plant with the cost of dyeing equal to 15-25% of the total cost.

Table 19. Compounds which can be recovered by membrane processes in the textile industry [49]

| Process | Compound |
|------------------------------------------|----------------------------------------------------------------------------------|
| desizing (removal of desizing agents) | starch carboxymethyl cellulose polyvinyl alcohol polyacrylates water |
| coating | latex |
| wool scouring | lanolin inflammable substances soda water |
| dyeing | dyes salts water |

Dye-containing effluents can be treated by pressure membrane processes:

- RO (single-stage) – complete removal of dyes and salts (disadvantage: increase of osmotic pressure),
- NF - concentration of dye baths and recovery of permeate containing salts.

Generally, two aspects of dye wastewater treatment can be distinguished:

- 1) integrated treatment processes with water recirculation to technological lines – minimizing water and energy demand,
- 2) treatment of effluents with no recirculation of water to technological lines – minimizing discharged wastewaters.

Fig. 10-25 presents a certain option of the first type of textile wastewater treatment system. Two processes, i.e. NF and RO are applied. NF is used directly to the exhausted dye baths whereas RO is used to treat used washing baths in a sequence line. This means that the last hot bath is treated first. The received permeate can be used as washing water in the former bath. Again, the used washing

bath is treated by RO to receive usable water. In this system, it is possible to reduce water demand by 60-70% and generated effluents by 90%.

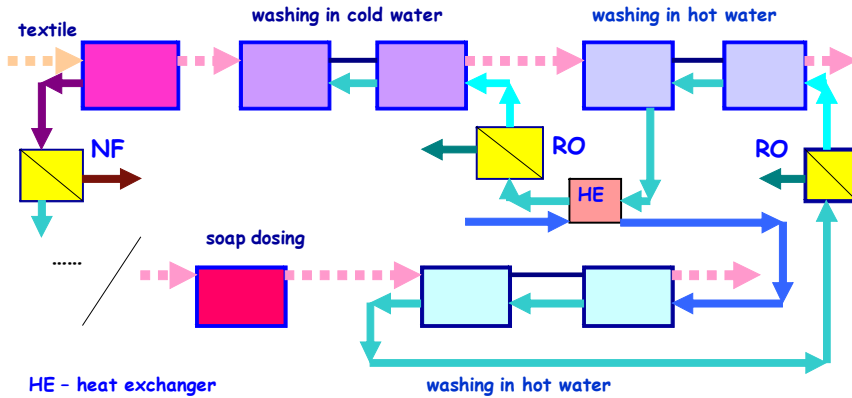

Fig. 10-25. Application of RO and NF in a dye-house – case I (based on [78])

Fig. 10-26 presents another option of the first type of textile wastewater treatment system. As in the previous case, the two membrane processes RO and NF are applied. As in the figure, each process or even each type of bath has its own membrane installation, which enables mainly water recovery. In this system, it is possible to reduce water demand by 50-60% and wastewater production by 90%.

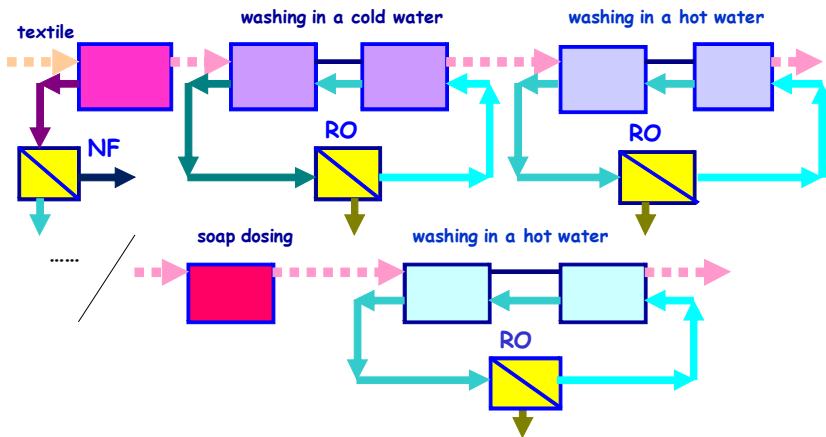

Fig. 10-26. Application of RO and NF in a dye-house – case II (based on [78])

In Fig. 10-27 a scheme of effluent treatment at the textile plant “La France Ind.” is shown. In this installation, dye-containing wastewater is treated by reverse osmosis in order to receive dye concentrates and water. Dye concentrates and water are then recirculated to the technological lines. Water recovery reaches 88-96%, dye recovery is possible at 67% and the recovery of auxiliary agents amounts to 75%. As seen from the data in Table 20, the treatment effects are excellent for the three various modules applied, although the hollow fiber module is characterized by a very low permeability.

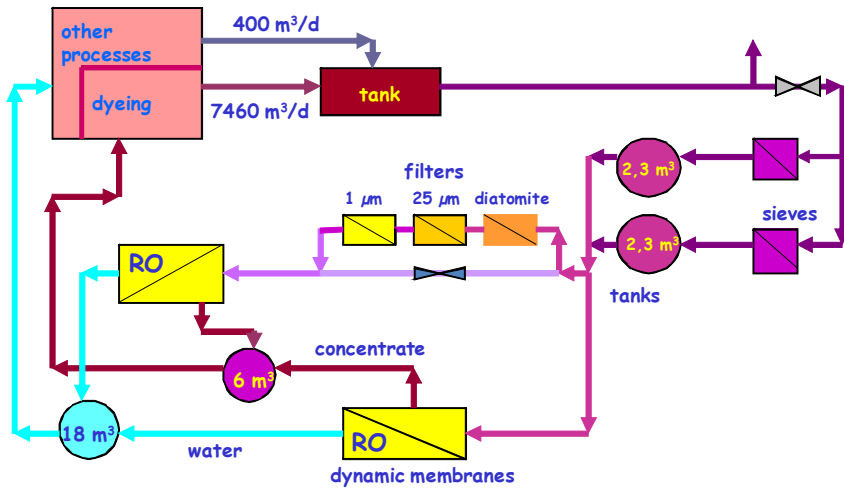

Fig. 10-27. Treatment and concentration of textile wastewater at the textile plant “La France Ind.” (USA) (based on [49])

Table 20. Treatment (RO/NF) effects of dye wastewater for various membrane modules (“La France Ind.”) [49]

| Parameter | Membrane module | | |
|-----------------------------------------------------|----------------------------|------------------------------|--------------------------|
| | UOP Roga 4100 spiral wound | Westinghouse U – 291 tubular | Du Pont B-9 hollow fiber |
| Material | cellulose acetate | cellulose acetate | polyamide |
| Membrane area, m ² | 17.6 | 0.83 | 162 |
| Pre-filtration | 25 µm | 25 µm | 25 µm and 1 µm |
| ΔP, MPa | 2.6 | 1.95 | 2.4 |
| Temp. °C | 15-25 | 13-32 | 12-32 |
| J _v , m ³ /m ² day | 0.624 | 0.432 | 0.096 |
| <u>Retention, %:</u> | | | |
| Total solids | 96 | 95 | 95 |
| Colour | 99.3 | 99.7 | 99.2 |
| COD | 96 | 71.7 | 96.7 |
| Conductivity | 95 | 87 | 92 |

It is also possible to treat textile wastewaters by MF [79], but the results are not as favorable (Table 21). MF should rather be a pre-treatment step prior to NF or RO.

Table 21. Treatment effects of textile wastewater by MF [49]

| Parameter | Raw effluents | MF permeate | R, % |
|---------------------------------|---------------|-------------|------|
| Conductivity, mS/cm | 10 | 7.89 | 21.1 |
| Total solids, g/dm ³ | 12.3 | 5.38 | 56.6 |
| COD, g/dm ³ | 760 | 225 | 70.4 |
| TOC, g/dm ³ | 175 | 61 | 65.2 |
| Color, ADMI | 1365 | 220 | 83.9 |

10.2.4. Whey processing

Membrane processes have been applied in food processing for more than 30 years. The main fields of membrane operation in the food industry are in the dairy industry (whey protein concentration, milk protein standardization, etc.), followed by the beverage industry (wine, beer, fruit juices, etc.) and the egg products industry.

In the dairy industry the following membrane processes can be applied [56]:

- reverse osmosis (RO) – concentration of milk and whey prior to evaporation, desalting of salt whey, wastewater treatment;
- nanofiltration (NF) – partial demineralization and concentration of whey;
- ultrafiltration (UF) – fractionation of milk for cheese manufacture, fractionation of whey for whey protein concentrates;
- microfiltration (MF) – clarification of cheese whey, defatting and reducing microbial load of milk;
- electrodialysis (ED) – demineralization of milk and whey.

An example of the successful application of membrane technology is the processing of whey. Whey is produced in the manufacture of cheese when milk is curdled by the addition of lactic acid. Typically, every 100 kg of milk produces about 80-90 kg of liquid whey. It has considerable nutritional value in the form of valuable proteins and lactose, but also a very high BOD value (30000-50000 g O₂/m³). Due to its high organic load, whey cannot be directly discharged to municipal waterways and thus whey disposal is a major problem for the dairy industry. Due to the unfavorable ratio of lactose to proteins (Table 22), it is very difficult to perform whey utilization. Whey solution has an osmotic pressure of 0.7 MPa which at a concentration of 25 wt% TS can reach 3.5 MPa. This limits the application of reverse osmosis as a pre-concentration step prior to evaporation and drying in order to obtain final whey powdered product.

Table 22. Whey composition [56]

| Component | Sweet whey | Salt whey |
|--------------------|-------------------|------------------|
| Total solids (wt%) | 6.60 | 6.90 |
| Protein (wt%) | 0.76 | 0.85 |
| Lactose (wt%) | 5.12 | 5.14 |
| Ash (wt%) | 0.61 | 0.53 |
| Fat (mass %) | 0.09 | 0.36 |

Formerly, whey was considered a useless by-product of cheese making fit only for field spreading as fertilizer. Currently, it has many uses in today's cheese making process along with being used worldwide as a nutritional food supplement. It is estimated that 50-60% of the whey produced is used primarily for animal feed and human food. There are several potential applications of membrane processes in the processing of whey including reverse osmosis (RO), ultrafiltration (UF), microfiltration (MF), electrodialysis (ED) and nanofiltration (NF). The appropriate membrane can simultaneously fractionate, purify and concentrate whey

components (Fig. 10-28) thus enhancing their utilization and reducing the pollution problem.

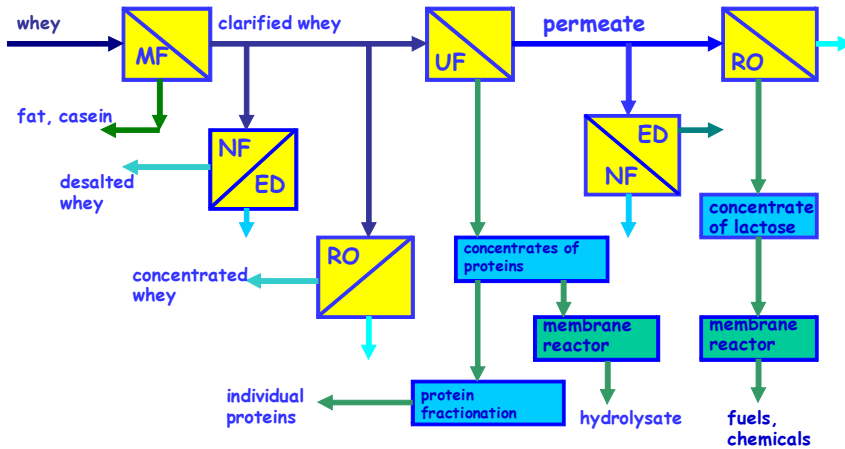

Fig. 10-28. Membrane processing of whey (based on [8])

Reverse osmosis of whey and ultrafiltration permeates produces whey protein concentrates, lactose and waste streams with reduced BOD. The pre-concentration of whey by reverse osmosis to 12 wt% TS (sometimes even to 24 wt% TS) is a common practice in the dairy industry. The whey concentrates are more efficient feeds for UF and demineralization by electrodialysis. During whey concentration by RO from 6.5 wt% TS to 25 wt% TS, the received permeate contains only 0.26 wt% TS.

Ultrafiltration is mainly used in whey fractionation to produce protein concentrates. By using UF, it is possible to increase the initial protein content from 10-12 dry wt.% to 35-80 dry wt.%. Following UF, the components can be fractionated, e.g. into α -lactoalbumin and β -lactoglobulin (Fig. 10-29). The final UF permeate contains useful lactose which can be a substrate in the pharmaceutical industry. The negative effect of membrane fouling can be reduced by appropriate pre-treatment such as the microfiltration of whey that can remove small quantities of fat present as globules (0.2-1.0 μm) and the casein present as fine particulates (5-100 μm). In the course of microfiltration, some precipitated salts and bacteria can also be removed.

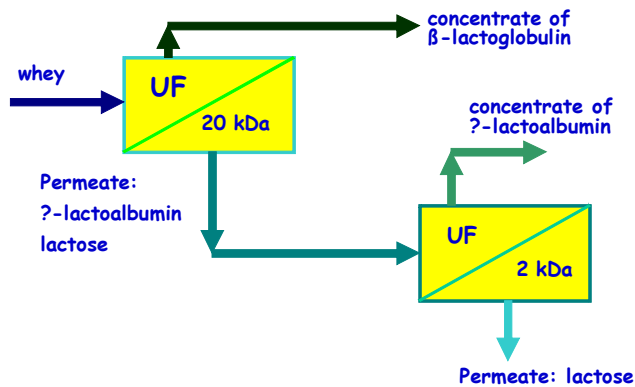

Fig. 10-29. Fractionation of whey proteins by UF (proteins: α -lactalbumin, molecular weight 14 kDa, β -lactoglobulin, molecular weight 37 kDa) (based on [8])

Whey demineralization can be performed by ion-exchange, electrodialysis and nanofiltration. Due to the high salt content in whey, the ion-exchange process is rather uneconomical (short operational cycles, large amounts of chemical regenerates). Electrodialysis, usually applied after the pre-concentration of whey, enables partial demineralization and thus further deionization can be achieved by ion-exchange. With nanofiltration it is possible to obtain a degree of desalination up to 40% which makes it possible to utilize whey in the next processing steps.

10.2.5. Recovery of metals from industrial effluents

Metal finishing comprises a broad range of processes that are practiced by most industries which manufacture metal parts. Finishing can be any operation that alters the surface of a work piece to achieve a certain property. This can be done by electroplating, electrolessplating, immersion plating, chemical and electrochemical conversion, cladding, case hardening, galvanizing, electropolishing and vapor deposition.

Effluents from electroplating processes contain compounds that are toxic and valuable at the same time such as a range of metals (nickel, chromium, zinc, copper, cadmium, etc.) and cyanide. These effluents are characterized by an acidic or alkaline pH and significant treatment before discharging is advisable. The wastewater usually stems from the rinsing of the plated element with water. Such rinsing is carried out in a countercurrent series resulting in an effluent which is too diluted to be recycled directly to the plating stage.

Membrane filtration with different types of membranes shows great promise for heavy metal removal due to its high efficiency, easy operation and space saving

attributes. By applying membrane processes, particularly reverse osmosis and nanofiltration, it is possible to recover the plating chemicals as a concentrated solution as well as pure water. Both streams can be reused in the technological process. Cu^{2+} , Ni^{2+} and Zn^{2+} ions were successfully removed by the RO process with the rejection efficiency in the range of 95-99.5 % [80]. The major drawback of RO is the high power consumption due to the pumping pressures.

Nanofiltration is a promising technique for the rejection of heavy metal ions such as nickel, chromium, copper and arsenic. The main advantage of the NF process is its comparatively low energy consumption and high removal efficiency. The maximum observed rejection of e.g. nickel ions was found to be 98% and 92% for an initial feed concentration of 5 and 250 mg/dm^3 , respectively [80].

Ultrafiltration is characterized by low energy demand, but the pore sizes of UF membranes are larger than the diameters of dissolved metal ions and these ions would easily pass through UF membranes. To obtain a high removal efficiency of metal ions, the micellar enhanced ultrafiltration (MEUF) and polymer enhanced ultrafiltration (PEUF) should be implemented. The MEUF process is based on the addition of surfactants to wastewater and the formation of micelles at a surfactant concentration greater than the critical micelle concentration CMC. These micelles can then bind to metal ions thus creating large metal-surfactant aggregates which can be easily retained by UF membranes (Fig. 10-30). The recovery and the reuse of surfactant are of utmost importance from the economical point of view. Similarly, in PEUF water-soluble polymers are used to form polymer-ion metal macromolecules which will be retained by UF membranes. Both MEUF and PEUF enable high removal of metal ions as Pb^{2+} , Zn^{2+} , Ni^{2+} , Cu^{2+} and Cr^{3+} . However, these methods make it impossible to directly reuse the valuable chemicals.

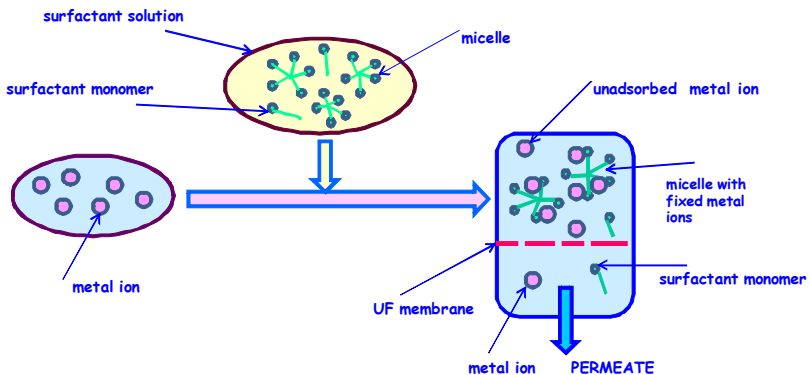

Fig. 10-30. Removal of metal ions by MEUF (based on [81])

10.2.6. Membrane bioreactors

Membrane biological reactors (MBR) consist of a biological reactor (bioreactor) with suspended biomass and a microfiltration membrane. The MF membrane with a nominal pore size ranging from 0.1 to 0.4 μm enables solid separation. MBR systems may be used with aerobic and anaerobic suspended growth bioreactors to separate treated wastewater from the active biomass. MBRs can be used for the treatment of municipal and industrial wastewater.

The MBR system utilizes a bioreactor and microfiltration as a single unit process for wastewater treatment thus replacing the secondary clarifier and the sand filter used for solids separation in a conventional activated sludge system (Fig.10-31). As a consequence, the technological line is simplified and space requirements are greatly reduced.

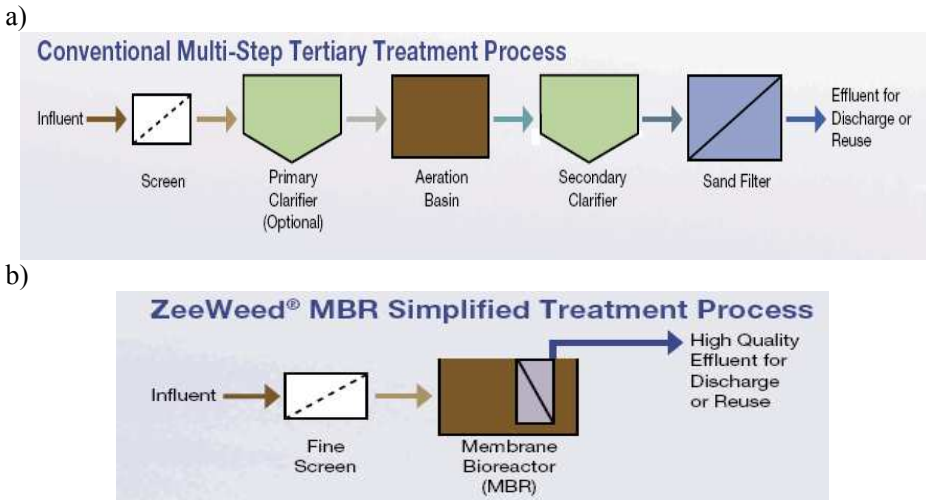

Fig. 10-31. Comparison of conventional (a) and MBR tertiary treatment process (b) (based on [82])

Membrane bioreactor systems have two basic configurations: a) the integrated bioreactor with immersed membranes, b) the recirculated MBR in which the mixed liquor circulates through a membrane module situated outside the bioreactor (Fig. 10-32).

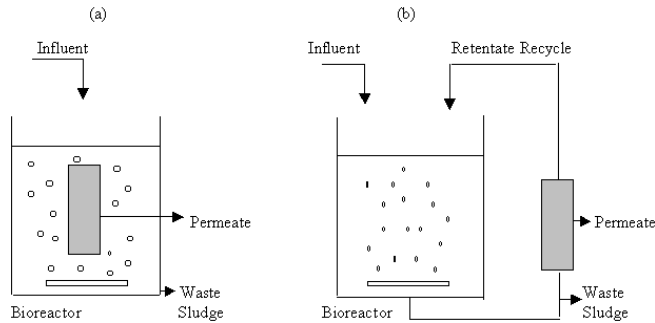

Fig. 10-32. Configurations of membrane bioreactors (MBRs): a) submerged MBR configuration with a membrane unit integrated into the bioreactor, b) side stream MBR configuration with a separate membrane filtration unit (based on [83])

In the integrated MBR the microfiltration membranes are immersed directly in the activated sludge reactor. The membranes, mainly hollow fibers, are mounted in modules (cassettes) and are subjected to a vacuum that draws treated wastewater through the membrane. The solids (biomass) are retained in the reactor. To maintain the TSS in the bioreactor and to clean the outer membrane surface, compressed air is distributed from the base of the membrane module. Air bubbles rise to the membrane surface causing a flow turbulence and membrane scouring occurs. The most common integrated MBR systems are manufactured by Zenon Environmental, Inc. (now the part of GE Power & Water) – ZeeWeed MBR and by Kubota Membrane Europe Ltd.

In a recirculated MBR system, activated sludge from the bioreactor is pumped to a pressure-driven tubular membrane where solids are retained inside the membrane and treated wastewater passes through the membrane to the outside. The solids are recycled to the activated sludge chamber. The membranes are systematically backwashed to remove solids. This type of MBR is produced by Lyonnaise-des-Eaux Degremont (France).

Membrane bioreactor technology effectively overcomes the problems associated with poor settling of sludge in a conventional activated sludge processes. The MBR systems can operate at higher mixed liquor suspended solids (MLSS) concentrations (15,000 to 25,000 mg/dm³) than conventional activated sludge processes [84] (Table 23). This optimizes nitrification and denitrification, while extending the sludge retention times to ensure complete nitrification and conversion of organic nitrogen compounds. MBR systems offer the option of independent selection of hydraulic residence time (HRT) and sludge retention time

(SRT) giving them greater flexibility in controlling operational parameters. An elevated biomass concentration allows for the highly effective removal of both soluble and particulate biodegradable material from the waste stream. Very low concentrations of effluent suspended solids, turbidity and BOD are produced that provide an effluent suitable for water reuse (Table 24). Because membranes are an absolute barrier for bacteria and also for viruses (with ultrafiltration), this allows for the production of high quality treated wastewater in a simple and compact system consisting of only a fine screen, an MBR and a reduced strength disinfection system. In addition, MBRs are automated, making them ideal for decentralized treatment because they are simpler to operate.

The economics of MBR technology depend on the following main factors:

- energy consumption,
- membrane lifecycle costs,
- filtration rates.

Generally, energy demand in MBR systems is higher than in conventional plants due to the additional energy consumption during the air scouring of membranes. Various module configurations can also affect the efficiency of aeration. The development of this technology has resulted in significant decreases in capital and operating costs; however, the energy costs remain high.

Table 23. Typical operational and performance data for a membrane bioreactor [84]

| Parameter | Unit | Range |
|------------------------------------------------|-------------------------------------|----------------|
| <u>Operational data:</u> | | |
| COD loading | kg/m ³ day | 1.2-3.2 |
| Mixed liquor suspended solids (MLSS) | mg/dm ³ | 5,000 - 25,000 |
| Mixed liquor volatile suspended solids (MLVSS) | mg/dm ³ | 4,000 - 16,000 |
| Solids retention time (SRT) | d | 5-20 |
| Hydraulic detention time (τ) | h | 4-6 |
| Food to biomass ratio | g COD/g MLVSS·day | 0.1-0.4 |
| Flux | dm ³ /m ² day | 600-1,100 |
| Applied vacuum | kPa | 4-35 |
| Dissolved oxygen (DO) | mg/dm ³ | 0.5-1.0 |
| <u>Performance data:</u> | | |
| Effluent BOD | mg/dm ³ | < 5 |
| Effluent COD | mg/dm ³ | < 30 |
| Effluent NH ₃ | mg/dm ³ | < 1 |
| Effluent TN | mg/dm ³ | < 10 |
| Effluent turbidity | NTU | < 1 |

The advantages of the MBR system can be summarized as follows:

- compact system - UF/MF instead of a secondary clarifier,
- the possibility of a higher biomass concentration in the sludge chamber,
- high BOD reduction, even 95%,
- long retention time,
- low-loaded activated sludge, complete mineralization and nitrification,
- small footprint and reduced capital costs.

REFERENCES

- [1] Kołtuniewicz A. The history and state of art in membrane technologies. Materials of VIII Spring Membrane School: Membranes, membrane processes and their applications. Opole-Turawa 23-26.04.2006.)
- [2] <http://www.earthlife.net/images/eury-cell.gif>
- [3] [http://faculty.ksu.edu.sa/al-saleh/Pictures Library/Forms/AllItems.aspx](http://faculty.ksu.edu.sa/al-saleh/Pictures%20Library/Forms/AllItems.aspx)
- [4] Glater L., The early history of reverse osmosis membrane development, *Desalination*, 1998, 117, 297-309.
- [5] Du Trochet H., *Nouvelles Recherches sur l'Endosmose et l'Exosmose*, J-B Baillière Paris, 1828
- [6] Reif O.W.. *Microfiltration Membranes: Characteristics and Manufacturing*. *Adv Biochem Engin/Biotechnol* (2006) 98: 73–103.
- [7] US membrane separation technology markets analyzed. Edited by Simon Atkinson. *Membrane Technology* September 2002, 10-12.
- [8] Cheryan M., *Ultrafiltration and microfiltration handbook*. 2nd edition, CRC Press 1998.
- [9] Yonekawa H., Oogink M., *Ceramic membranes: the future for drinking water production*. www.rwbwaterservice.nl
- [10] Mueller U., Witte M., *Ceramic membranes – Case related protocol for optimal operational conditions to treat filter backwash water*. TECHNEAU, May 2007.
- [11] *Water Treatment Membrane Processes*. Ed. J. Mallevalle, P.E. Odendaal, M.R. Wiesner, McGraw-Hill 1996.
- [12] Semiat R., *Water global needs – down to Mediterranean and Middle East problems*. 2nd Membrane Science and Technology Conference of Visegrad Countries, 18-22 September 2005, Polanica Zdrój, Poland.
- [13] Khulbe K.C., Feng C.Y., Matsura T., *Synthetic Polymeric Membranes Characterization by Atomic Force Microscopy*, Springer-Verlag, Berlin 2008.
- [14] *Handbook of Industrial Membrane Technology*, ed. M.C. Porter, Noyes Pub. 1990.
- [15] Gore R.W., U.S. Pat. 4,187,390 (May 5, 1980).
- [16] Mulder M., *Basic Principles of Membrane Technology*, Kluwer Acad.Pub. 1991.
- [17] *Bioseparation and bioprocessing: a handbook*, Volume 1, Ed. G. Subramanian, Wiley-VCH 2007.
- [18] *Membrane Separation Technologies (US industry forecast for 2014 & 2019)*. The Freedonia Group Report n°116818. 05/2010.
- [19] Ayrál A., *Introduction to baromembrane techniques*. French-Serbian Summer School , Vrnjicka Banja, Serbia, 7-13 October 2007.
- [20] *Membrane Filtration, A National Drinking Water Clearinghouse Fact Sheet*. Tech Brief. March 1999.
- [22] Kabsch-Korbutowicz M., *Ultrafiltration as a method of separation of natural organic matter from water*. *Materials Science - Poland*, 26(2) (2008) 459-467.
- [22] Furukawa D.H., *A Global Perspective of Low Pressure Membranes*. NWRI Final Project Report, March 2008.
- [23] Beier S.P., *Pressure Driven Membrane Processes*, 2007. ISBN 87-7681-152-2. <http://bookboon.com>

- [24] Gryta M., Ciśnieniowe techniki membranowe, Szkoła membranowa 2007.
- [25] Global Desalination Investment to Double, Water Link International. no.114, 7 July 2010.
- [26] Weening J.J., Advancing Nephrology Around the Globe: An Invitation to Contribute. J Am Soc Nephrol 15: 2761-2762, 2004.
- [27] Membrane Filters for Water Treatment. http://downloads.germanpavilion.com/downloads/pdf/exhibitor_18314.pdf
- [28] Advanced Membrane Technology and Applications. ed. N.N. Li, A.G. Fane, W.S.W. Ho, T. Matsuura, Wiley 2008.
- [29] Baker R., Future directions of membrane gas-separation technology, Membrane Technology, 2001, Issue 138, October 2001, 5-10.
- [30] Bernardo P., Drioli E., Golemme G., Membrane Gas Separation: A Review/State of the Art, Ind. Eng. Chem. Res. 2009, 48, 4638–4663.
- [31] Shao P., Huang R.Y.M., Polymeric membrane pervaporation, Journal of Membrane Science 287 (2007) 162–179.
- [32] Huang, R.Y.M., Pervaporation Membrane Separation Processes, Elsevier Science Publishers B.V., Amsterdam 1991.
- [33] Changing the Climate. Ethanol Industry Outlook 2008. www.ethanolrfa.org/resource/facts/trade/
- [34] Huang Y, Vane L. M., BioSep™: A New Ethanol Recovery Technology for Small Scale Rural Production of Ethanol from Biomass. <http://www.mtrinc.com/publications/PER01%20MTR%20BioSep%20Process%20for%20Bioethanol%20Production%20Pres.pdf>
- [35] Liquid Membranes. Principles and Applications in Chemical Separations and Wastewater Treatment, Ed. Vladimir Kislik, Elsevier 2009.
- [36] Mohamed Souhaimi Khayet, Matsuura T., Membrane Distillation. Principles and Applications, Elsevier 2010.
- [37] Gryta M., Application of membrane distillation process for tap water purification. Membrane Water Treatment, Vol. 1, No. 1 (2010) 1-12.
- [38] Tomaszewska M., Membrane Distillation - Examples of Applications in Technology and Environmental Protection. Polish Journal of Environmental Studies Vol. 9, No. 1, 2000, 27-36.
- [39] Rautenbach R., Procesy membranowe, WNT, Warszawa 1996.
- [40] Wiśniewski J., Prądowe techniki membranowej separacji, Wodociągi-Kanalizacja, 4(38) (2007) 26-3.
- [41] Electrodialysis - a method to deionize water and to recover the salt, <http://www.pca-gmbh.com/appli/ed.htm>
- [42] JSC Membrane Technologies, www.mt.rusmed.ru.
- [43] <http://www.fumatech.com/EN/Membrane-technology/Membrane-processes/Bipolar-membranes/>
- [44] Closuit E., Electrodeionization: A case study for POU dealers, Water Technology Magazine, Volume 25, Issue 5 - May 2002.
- [45] Tzahi Y. Cath, Emerging Applications for Water Treatment and Potable Water Reuse, 2006 International Conference on Environmental Systems, July 17-20, 2006.

- [46] Majewska-Nowak K., Kabsch-Korbutowicz M., Winnicki T., The effect of gas bubble flow on ultrafiltration efficiency, *Desalination* 126 (1999) 187-192.
- [47] Gleick, P. H., Water resources. In *Encyclopedia of Climate and Weather*, ed. by S. H. Schneider, Oxford University Press, New York 1996, vol. 2, pp. 817-823.
- [48] *Desalination for Safe Water Supply – Guidance for the Health and Environmental Aspects to Desalination*, World Health Organization, Geneva 2007.
- [49] Bodzek M., Bohdziewicz J., Konieczny K., *Techniki membranowe w ochronie środowiska*, Wydawnictwo Politechniki Śląskiej, Gliwice 2007.
- [50] Sauvet-Goichon B., Ashkelon desalination plant – A successful challenge, *Desalination* 203 (2007) 75-81.
- [51] Wilf M., *Advanced membrane technology for water reclamation*, Hydranautics, http://www.membranes.com/docs/papers/18_watertech.pdf
- [52] Bodzek M., Konieczny K., *Wykorzystanie procesów membranowych w uzdatnianiu wody*, Wydawnictwo Projprzem-EKO, Bydgoszcz 2005.
- [53] Judd S., Jefferson B., *Membranes for Industrial Wastewater Recovery and Re-use*, Elsevier, Oxford 2003.
- [54] Skwara J., *Elektrodejonizacja wody dla potrzeb technologicznych*, Energetyka, <http://www.elektroenergetyka.pl>
- [55] *Power industry*, The McIlvaine Company, <http://www.mcilvainecompany.com/generic%20applications/water/power.htm>
- [56] Scott K., *Handbook of industrial membranes*, Elsevier Science Publishers Ltd., Oxford 1995.
- [57] Majewska-Nowak K., Kabsch-Korbutowicz M., Dodż M., Effects of natural organic matter on atrazine rejection by pressure driven membrane processes, *Desalination* 147 (1-3) (2002) 281-286.
- [58] Majewska-Nowak K., Kabsch-Korbutowicz M., Dodż M., Removal of pesticides from natural waters, *Environment Protection Engineering* 27(2) (2001) 55-69.
- [59] Cyna B., Chagneau G., Bablon G., Tanghe N., Two years of nanofiltration at the Méry-sur-Oise plant, France, *Desalination* 147 (2002) 69-75.
- [60] Kabsch-Korbutowicz M., Effect of Al coagulant type on natural organic matter removal efficiency in coagulation/ultrafiltration process, *Desalination* 185 (2005) 327-333.
- [61] Kabsch-Korbutowicz M., Impact of pre-coagulation on ultrafiltration process performance, *Desalination* 194 (2006) 232-238.
- [62] Kabsch-Korbutowicz M., Removal of natural organic matter from water by in-line coagulation/ultrafiltration process. *Desalination* 200(1-3) (2006) 421-423.
- [63] Kabsch-Korbutowicz M., Majewska-Nowak K., Winnicki T., Study of water treatment by an integrated coagulation-ultrafiltration process. *Chemical and Process Engineering*. 28(1) (2007) 67-74.
- [64] Kabsch-Korbutowicz M., Biłyk A., Molczan M., The effect of feed water pretreatment on ultrafiltration membrane performance. *Polish Journal of Environmental Studies* 15(5) (2006) 719-725.
- [65] Kabsch-Korbutowicz M., Majewska-Nowak K., Winnicki T., Water treatment using MIEX DOC/ultrafiltration process. *Desalination* 221(1-3) (2008) 338-344.

- [66] Kabsch-Korbutowicz M., Urbanowska A., Water treatment in integrated process using ceramic membranes. *Polish Journal of Environmental Studies* 19(4) (2010) 731-737.
- [67] Kabsch-Korbutowicz M., Majewska-Nowak K., Zastosowanie zintegrowanych procesów membranowych do usuwania substancji organicznych z wody. *Ochrona Środowiska* 32(3) (2010) 27-32.
- [68] Pressdee J.R., Veerapaneni S., Shorney-Darby L.S., *Integration of Membrane Filtration Into Water Treatment Systems*, Awwa Research Foundation 2006.
- [69] Majewska-Nowak K., Usuwanie barwników organicznych z roztworów wodnych w procesie ultrafiltracji w obecności anionowej substancji powierzchniowo-czynnej, *Ochrona Środowiska* 3 (2006) 15-24.
- [70] Majewska-Nowak K., Kabsch-Korbutowicz M., Winnicki T., Capillary membranes for separation of dye particles, *Desalination* 105(1-2) (1996) 91-103.
- [71] Majewska-Nowak K., Kabsch-Korbutowicz M., Winnicki T., Concentration of organic contaminants by ultrafiltration, *Desalination* 221(1-3) (2008) 358-369.
- [72] Majewska-Nowak K., Kowalska I., Kabsch-Korbutowicz M., Ultrafiltration of SDS solutions using polymeric membranes. *Desalination* 184(1-3) (2005) 415-422.
- [73] Majewska-Nowak K., The effect of a polyelectrolyte on the efficiency of dye-surfactant solution treatment by ultrafiltration, *Desalination* 221 (1-3) (2008) 395-404.
- [74] Majewska-Nowak K., Wpływ polielektrolitu na skuteczność ultrafiltracji roztworów wodnych zawierających barwniki organiczne i substancję powierzchniowo czynną, *Ochrona Środowiska* 4 (2006) 4-10.
- [75] Majewska-Nowak K., Kowalska I., Kabsch-Korbutowicz M., The effect of surfactants on organic dye separation by ultrafiltration, *Desalination* 200 (1-3) (2006) 283-285.
- [76] Majewska-Nowak K., Concentration of dye solutions in the presence of surfactant and mineral salts, *Environment Protection Engineering* 32(2) (2006) 77-91.
- [77] Majewska-Nowak K., Kabsch-Korbutowicz M., Winnicki T., Salt effect on the dye separation by hydrophilic membranes. *Desalination* 108(1-3) (1996) 221-229.
- [78] J.P. van t Hul, Membrane separation in textile washing processes, Thesis Enschede, Twente University 1999, <http://doc.utwente.nl/9392/1/t000000e.pdf>
- [79] Majewska-Nowak K., Kabsch-Korbutowicz M., Application of low-pressure membrane processes to dye effluents treatment, *Environment Protection Engineering* 25 (3) (1999) 139-144.
- [80] Fu F., Wang Q., Removal of heavy metal ions from wastewaters: A review, *Journal of Environmental Management* (2010), doi:10.1016/j.jenvman.2010.11.011
- [81] Micellar Enhanced Ultrafiltration, Indian Institute of Technology, Kanpur, India <http://www.iitk.ac.in/che/pkb-rc-app-res.htm>
- [82] GE Water & Process Technologies, ZeeWeed Membranes for Municipal Wastewater Treatment; <http://www.mabarex.com/document.php?id=77&lid=2>
- [83] Mallia H., Till S., Membrane bioreactors: wastewater treatment applications to achieve high quality effluent, 64th Annual Water Industry Engineers and Operators' Conference, All Seasons International Hotel – Bendigo 5 and 6 September, 2001, http://www.wioa.org.au/conference_papers/2001/pdf/paper8.pdf
- [84] Metcalf and Eddy, Inc., *Wastewater Engineering, Treatment and Reuse*, McGraw Hill 2003.