

ZWEITER NACHTRAG

ZUM

LEHRBUCH

DER

AUFBEREITUNGSKUNDE

VON

P. RITTER VON RITTINGER

ATLAS

VIII TAFELN

✓

1913. 1375.

BERLIN

VERLAG VON ERNST & KORN

(GROPIUS'SCHE BUCH- UND KUNSTHANDLUNG)

1873.

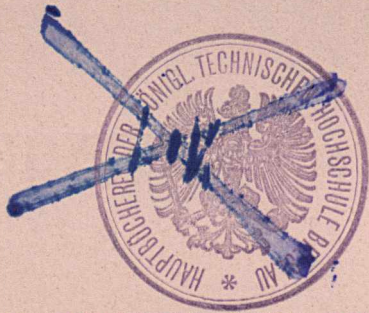

Verzeichnifs der Figurentafeln.

Tafel XXXXII	Figur 308 bis 313
- XXXXIII	- 314 - 322
- XXXXIV	- 323 - 327
- XXXXV	- 328 - 332
- XXXXVI	- 333 - 339
- XXXXVII	- 340 - 341
- XXXXVIII	- 342 _a - 342 _i
- XXXXIX	- 342 _k - 349



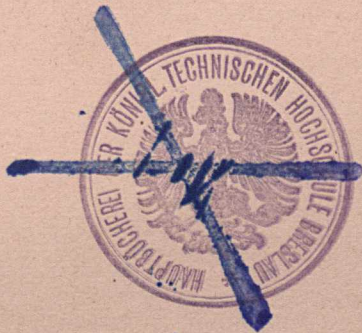

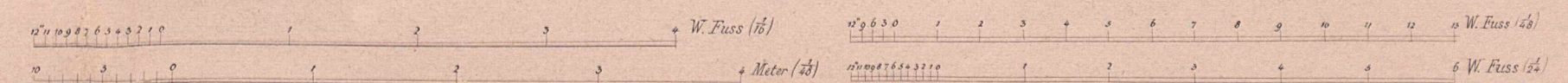
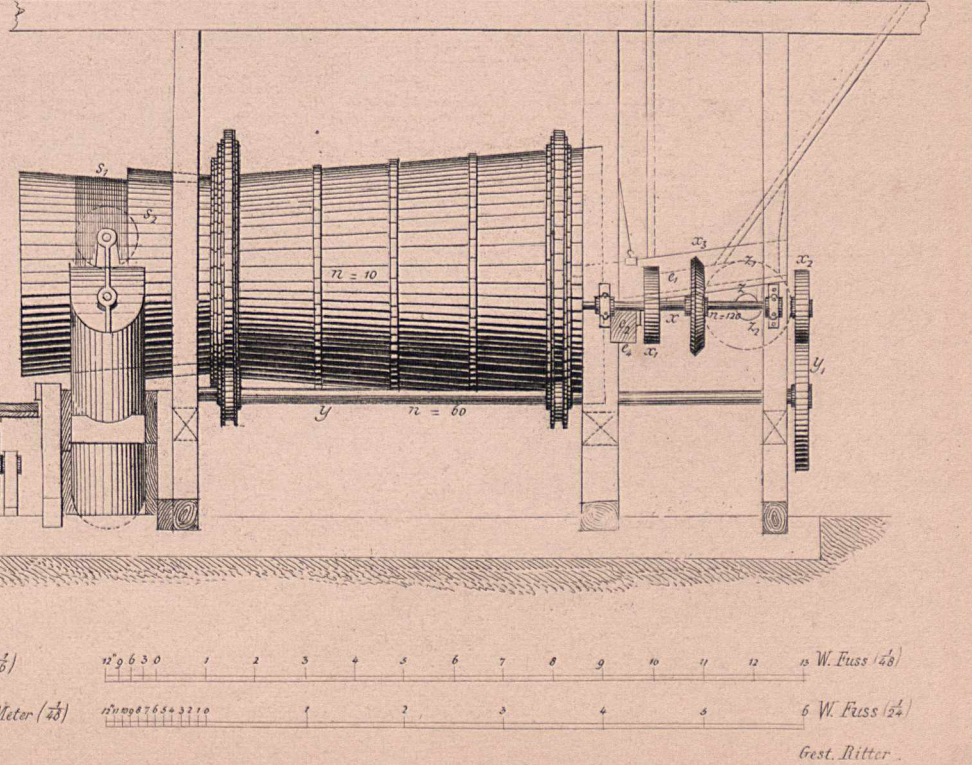
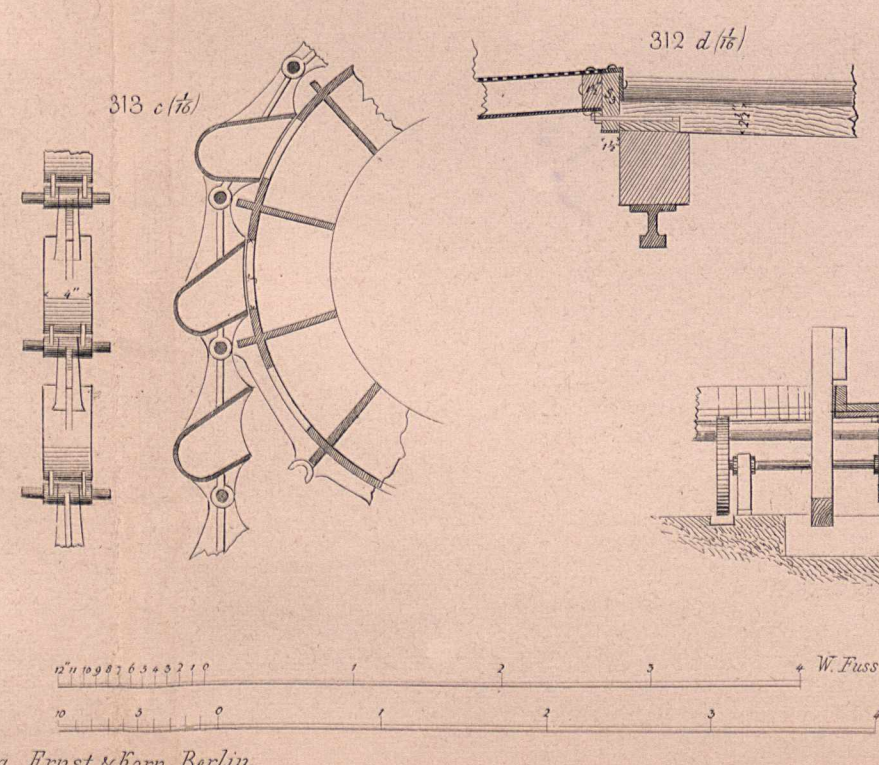
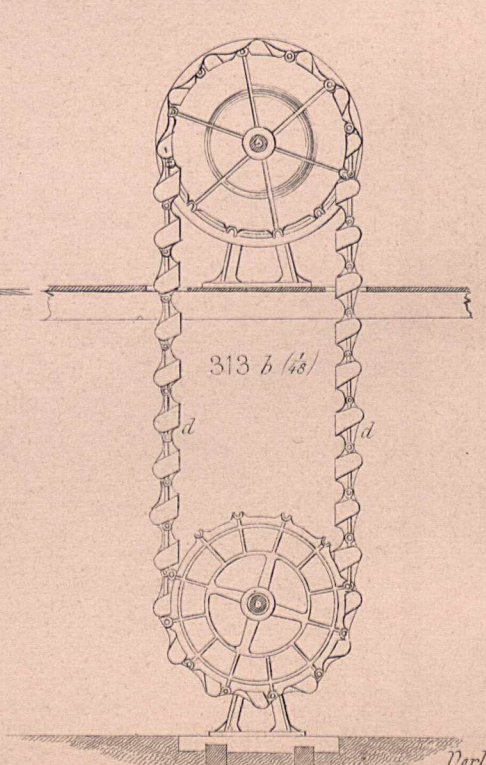
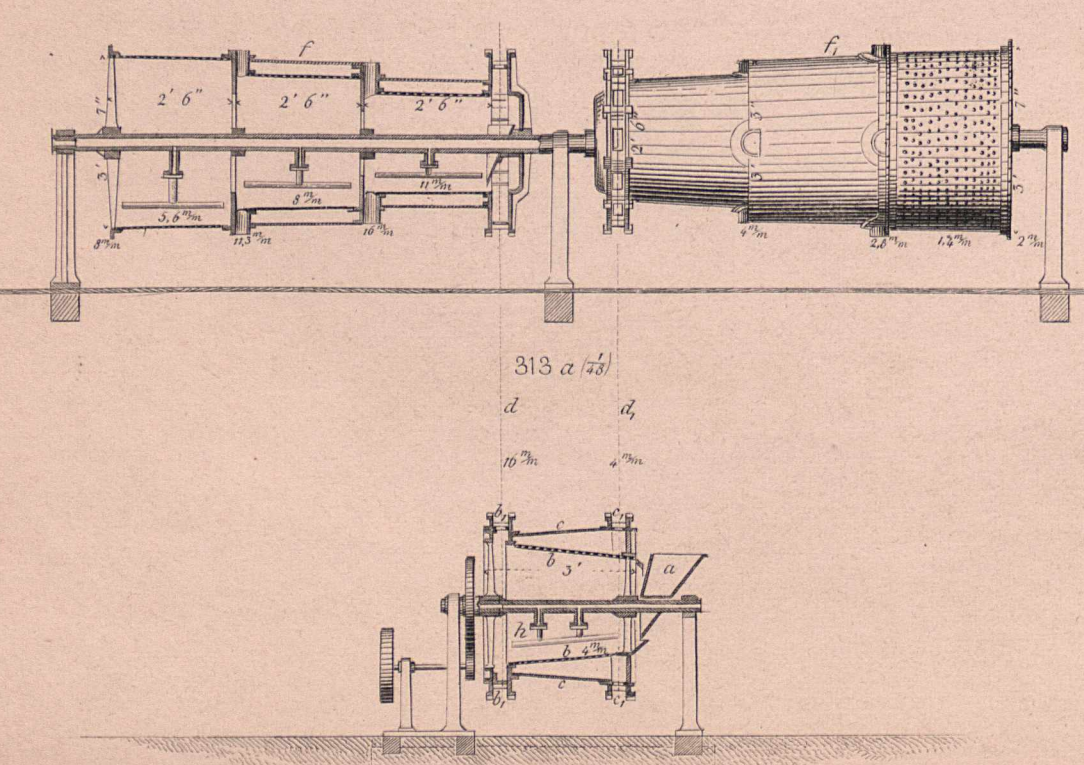
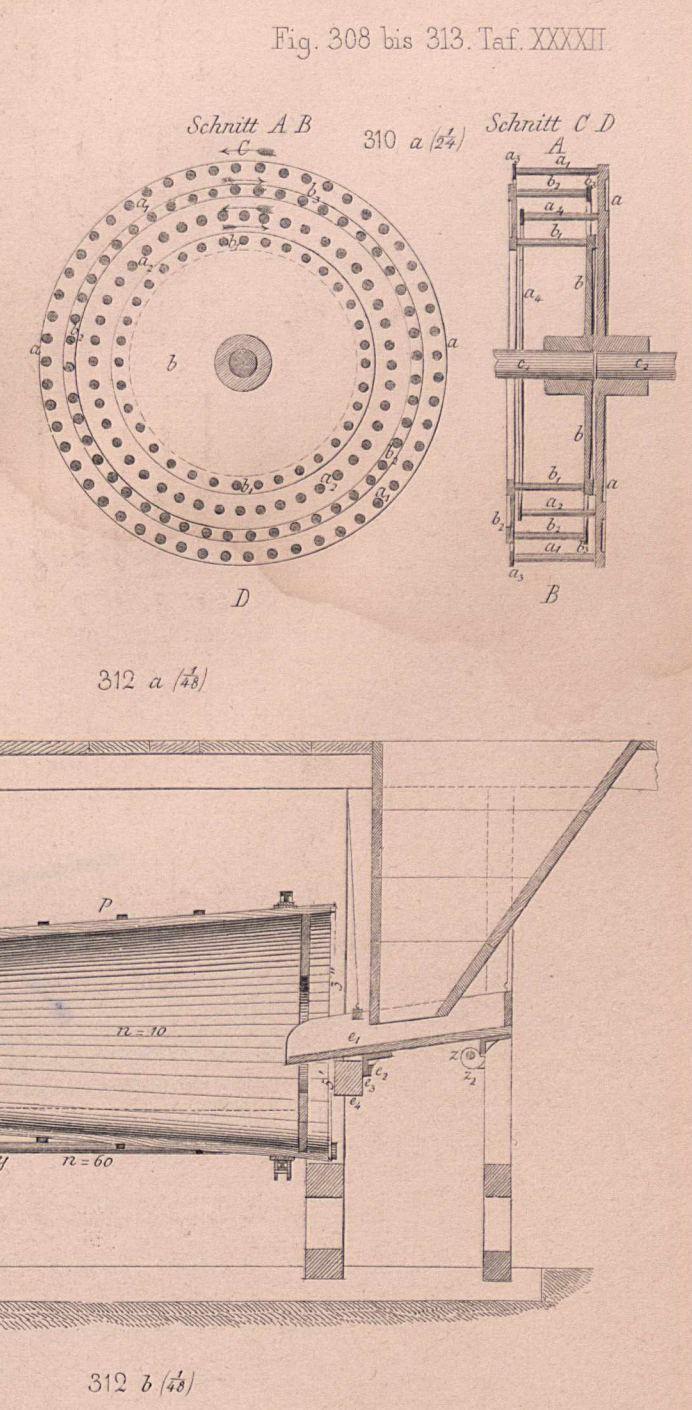
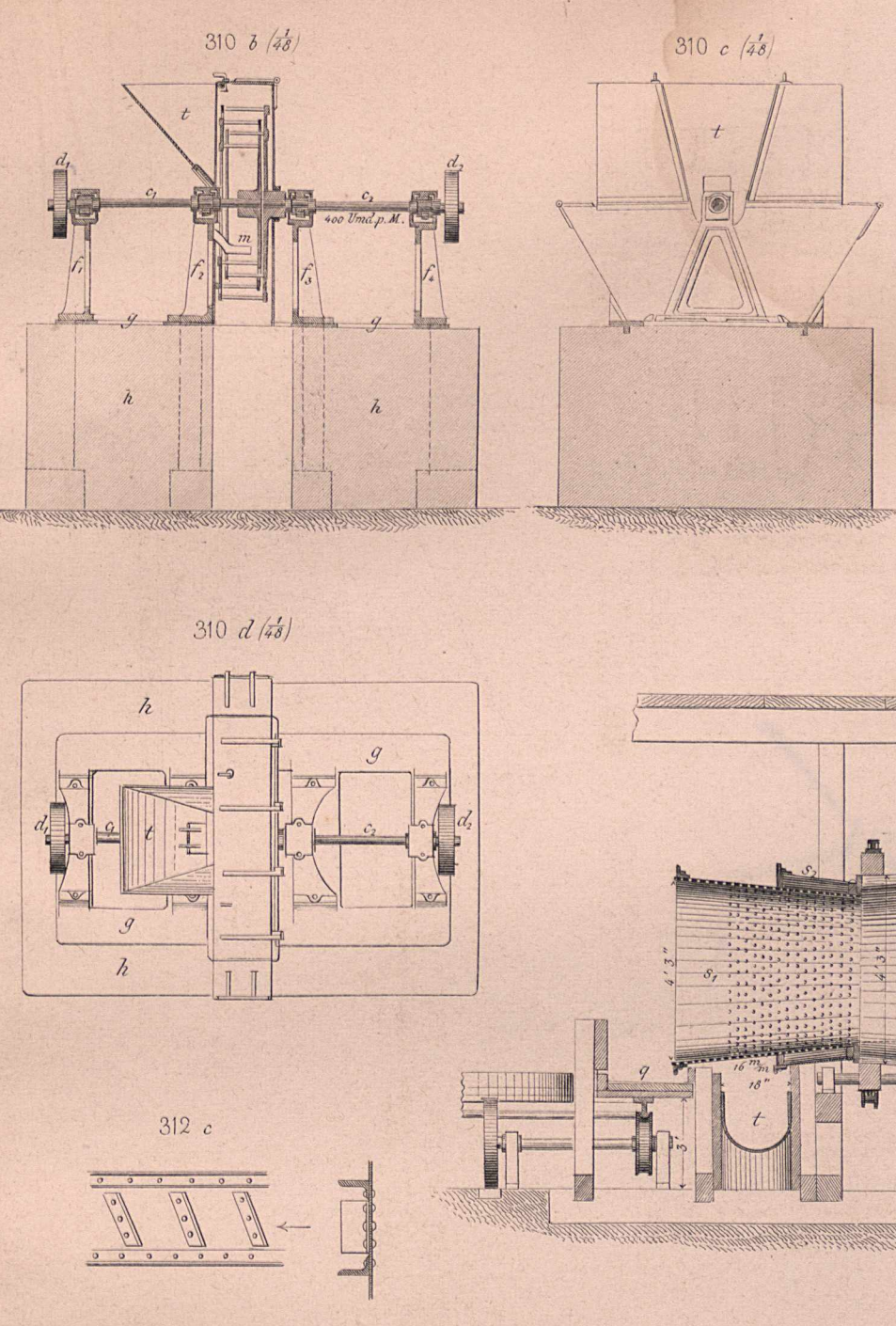
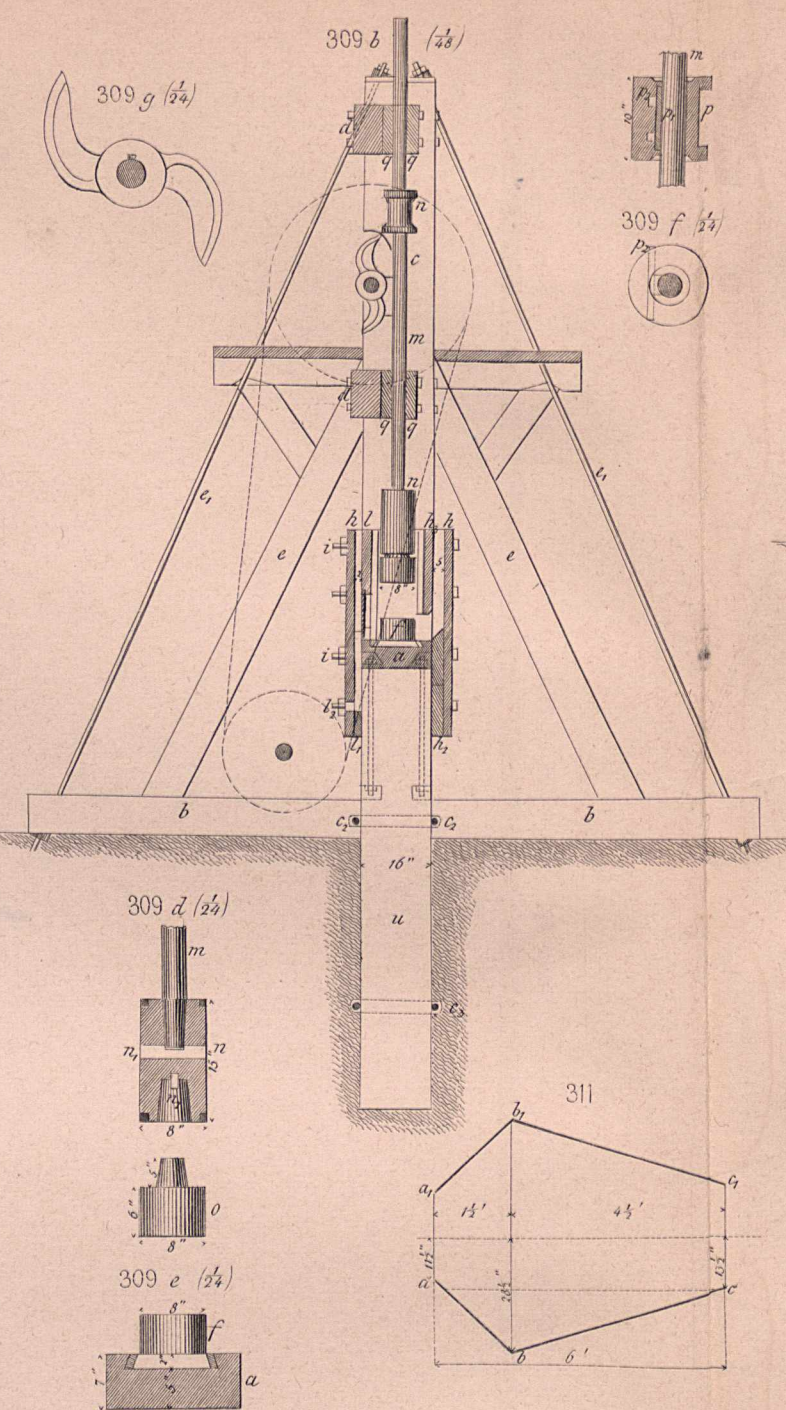
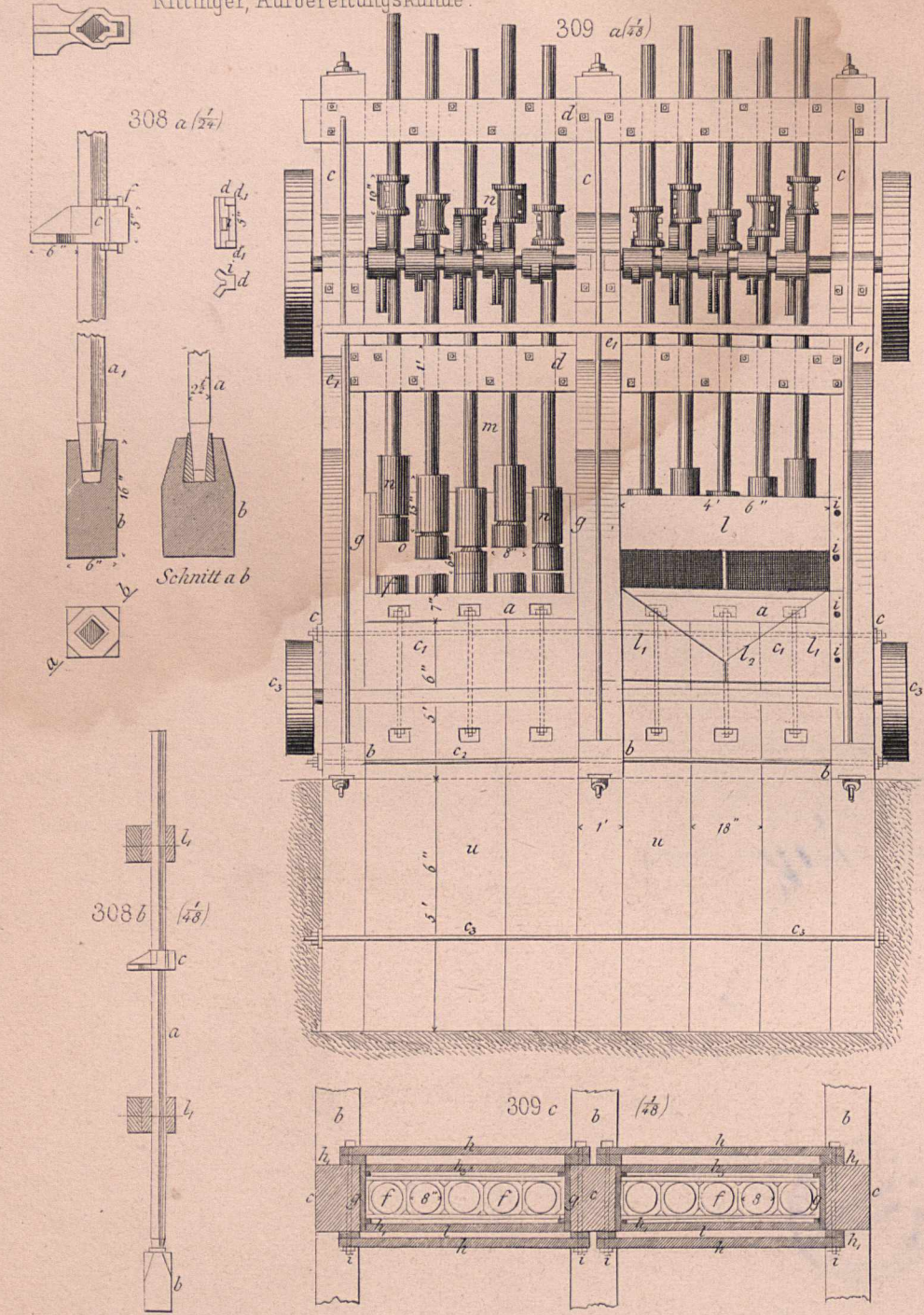



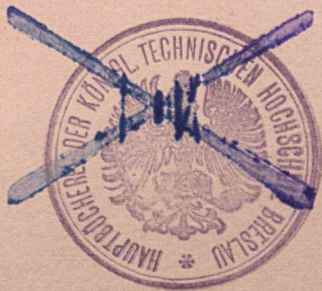

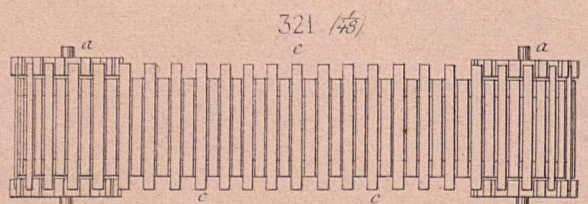
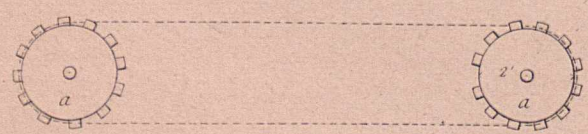
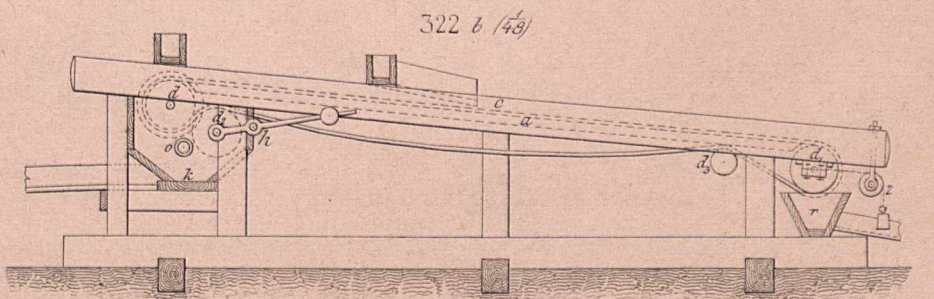
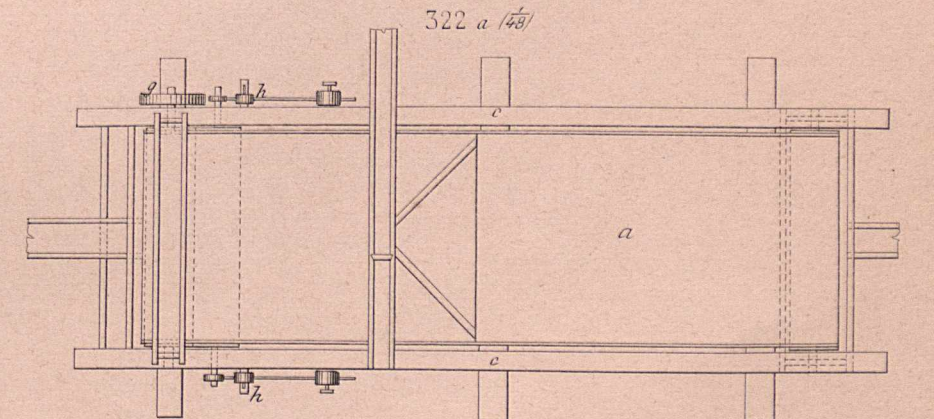
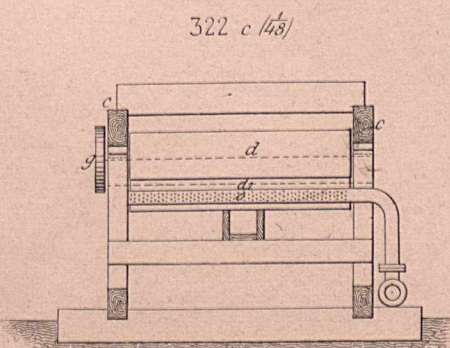
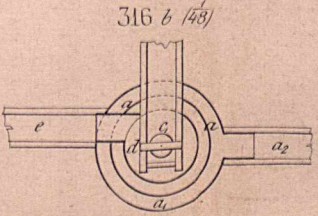
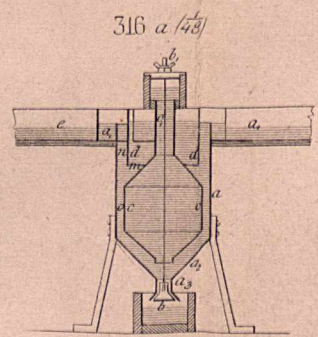
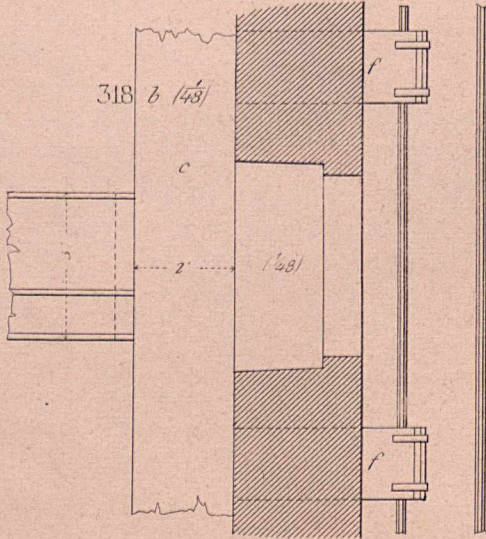
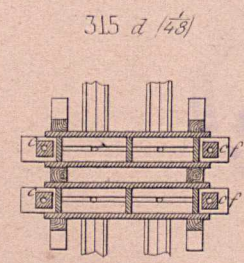
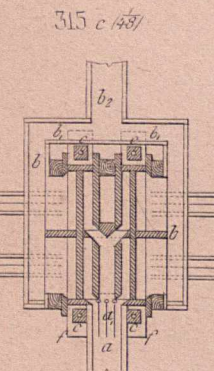
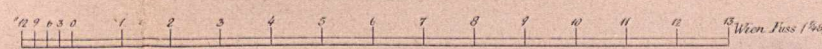
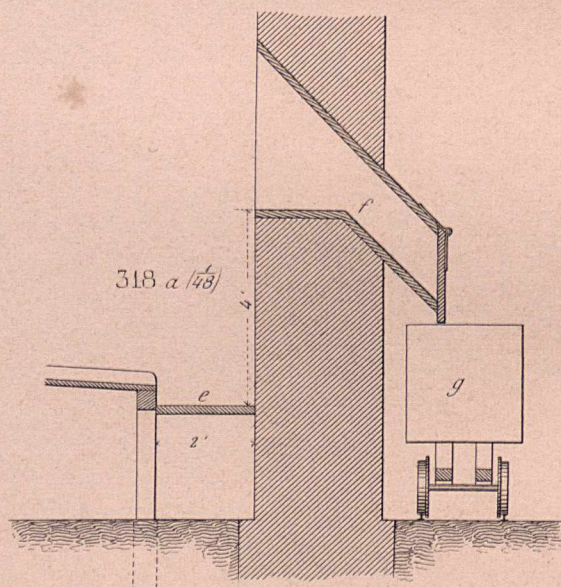
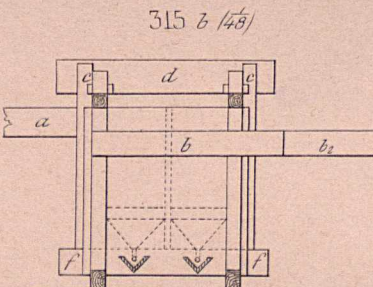
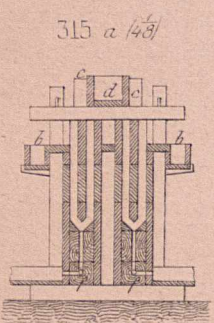
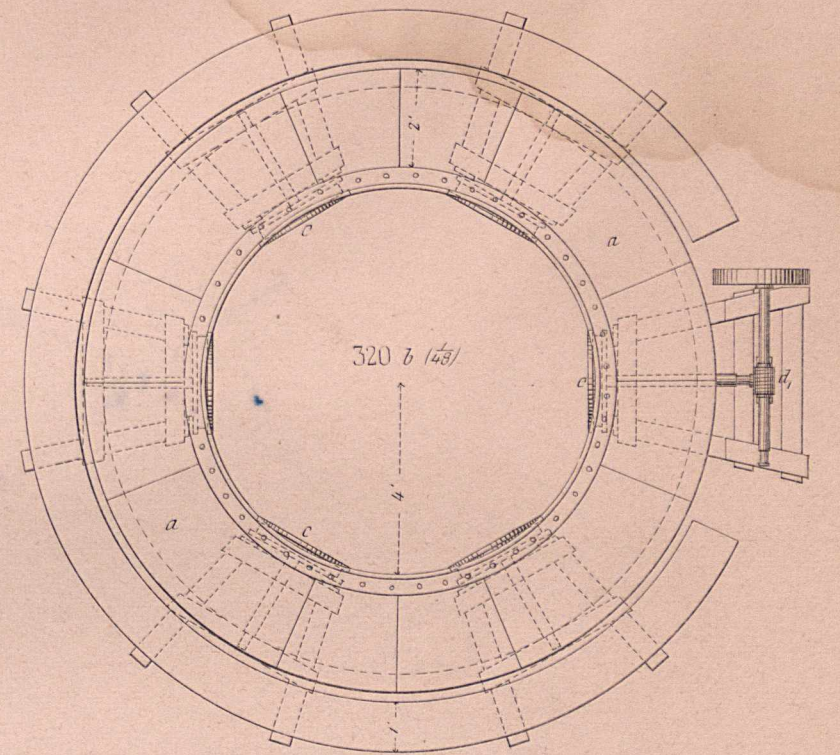
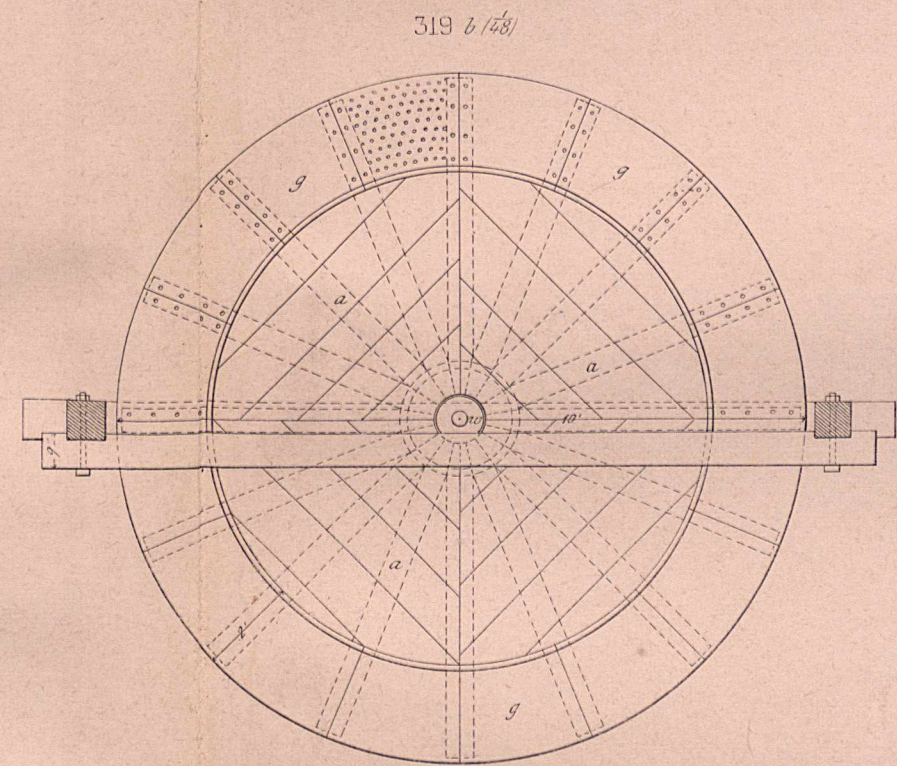
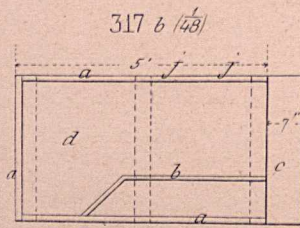
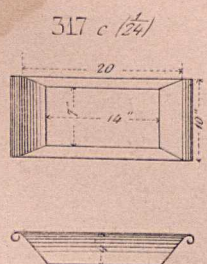
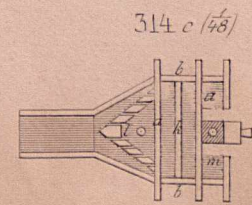
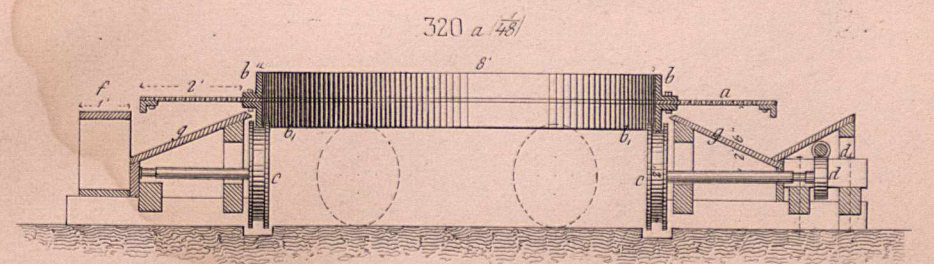
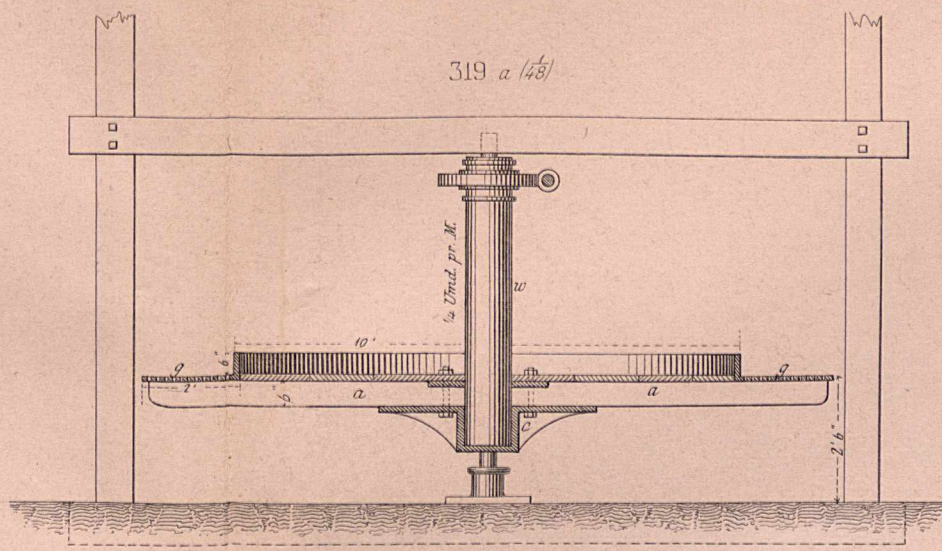
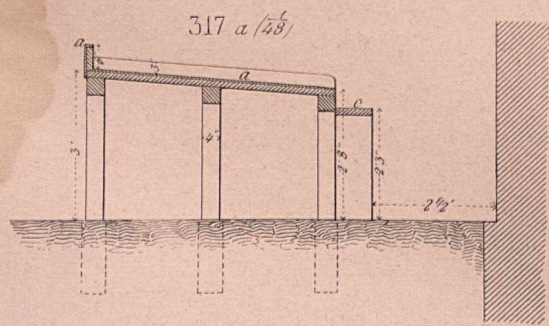
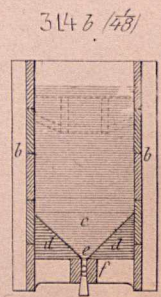
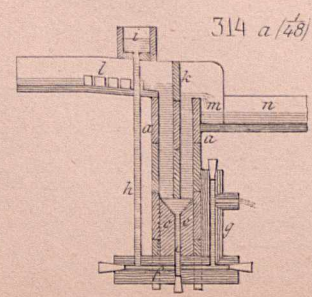





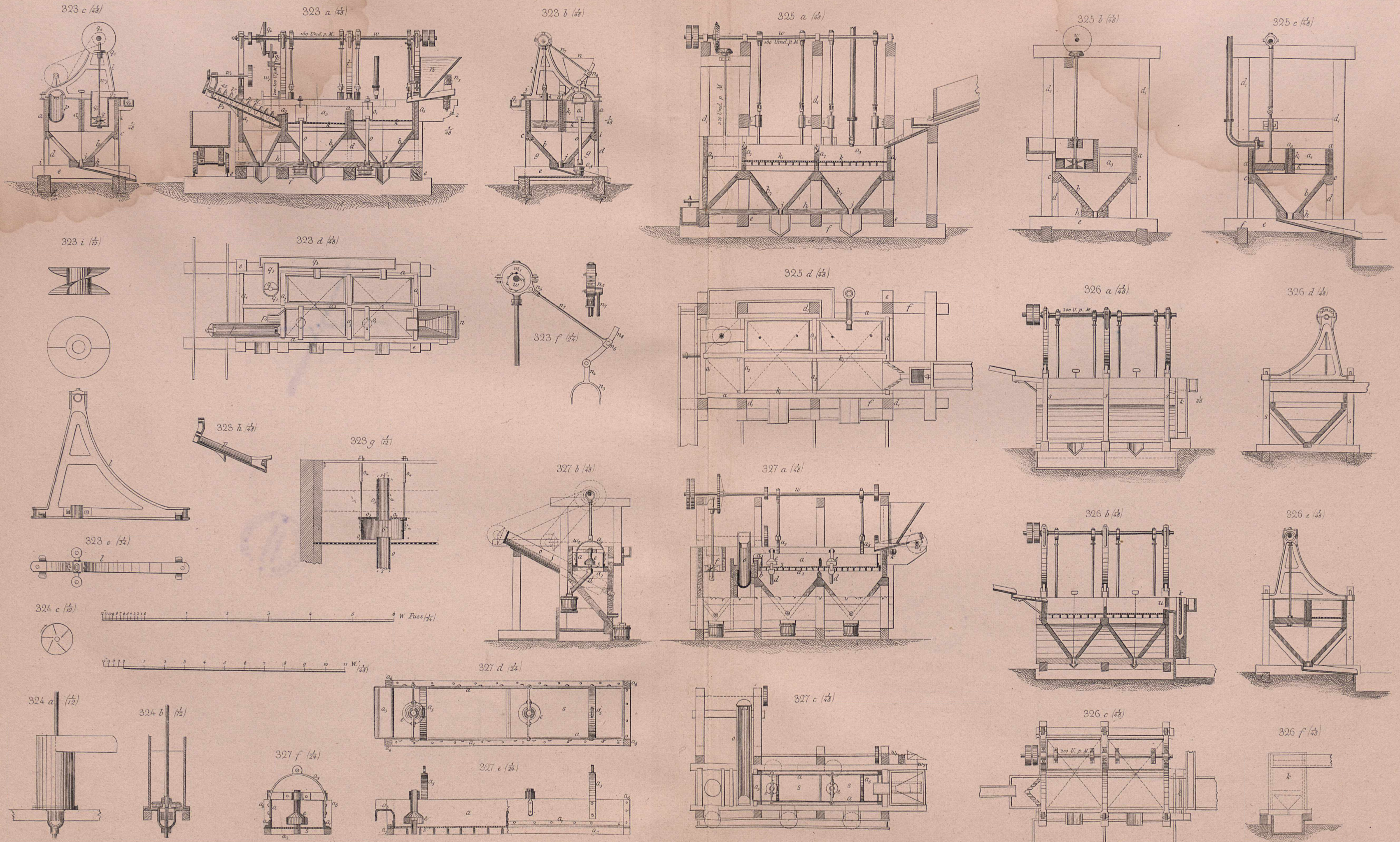



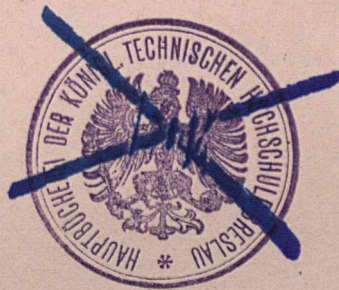

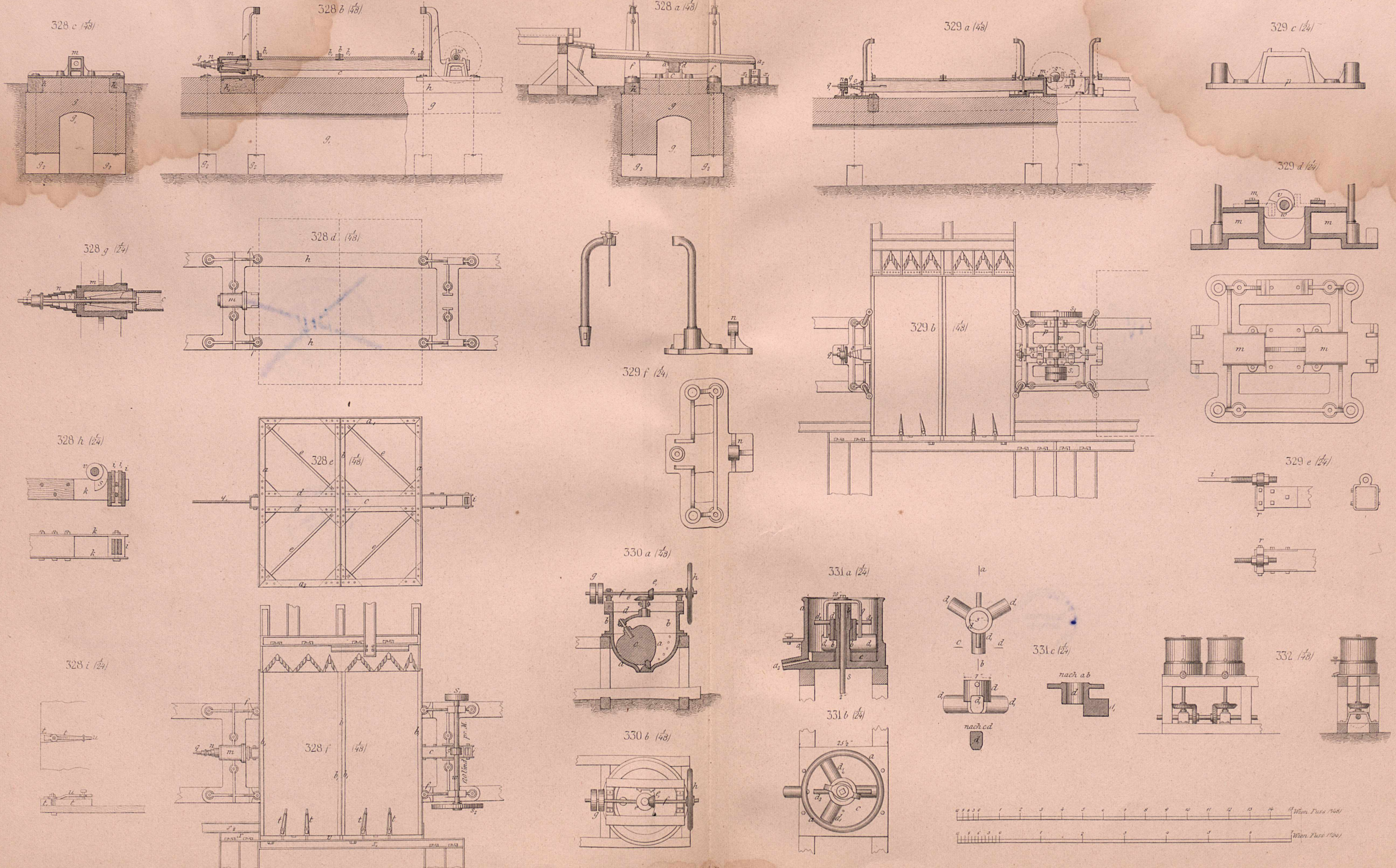

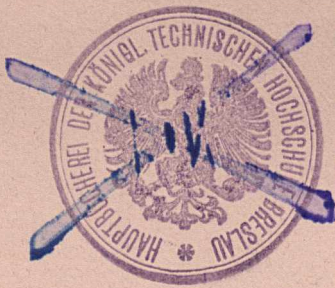



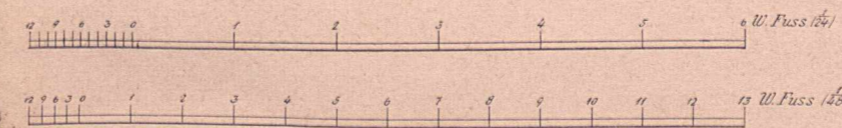
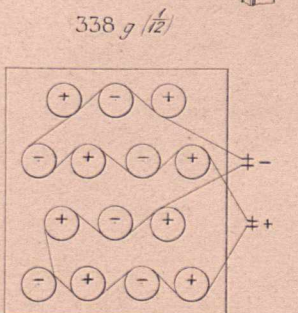
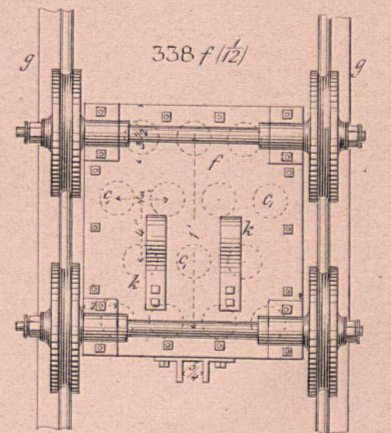
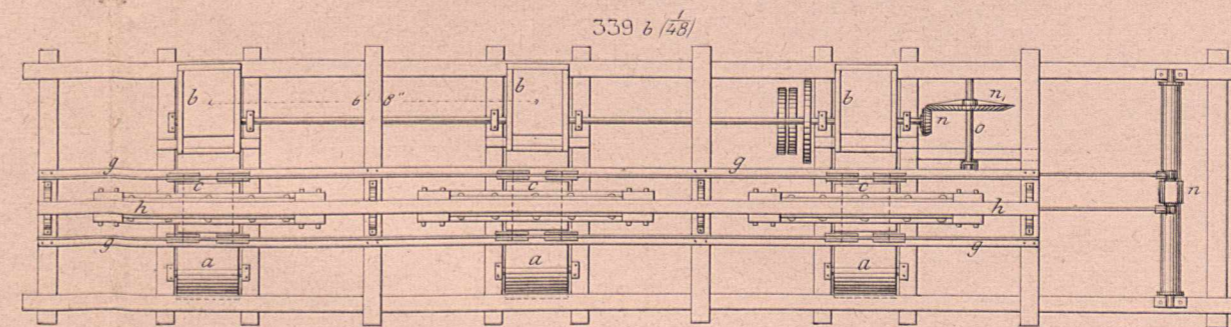
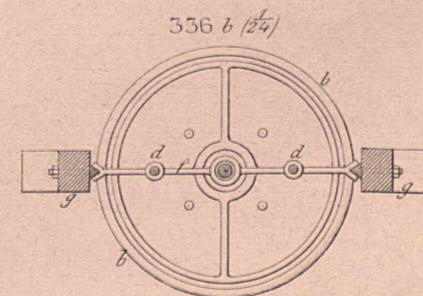
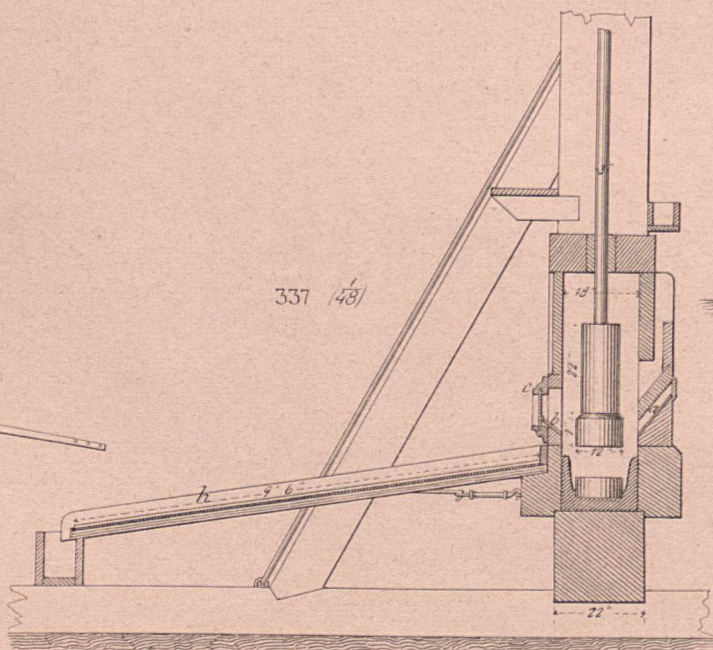
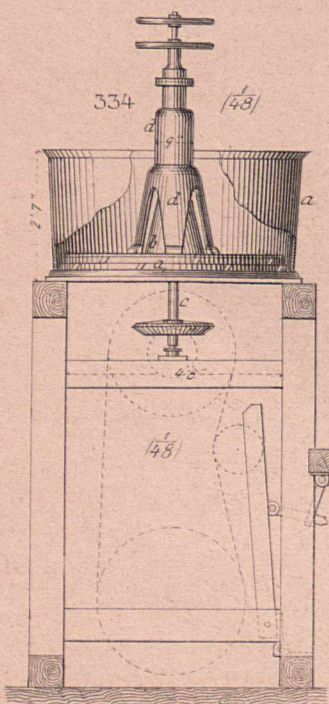
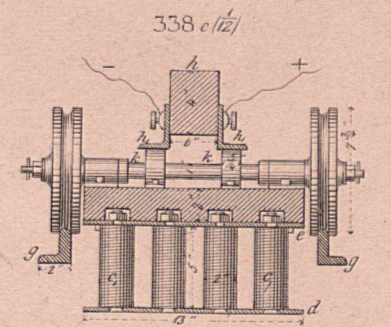
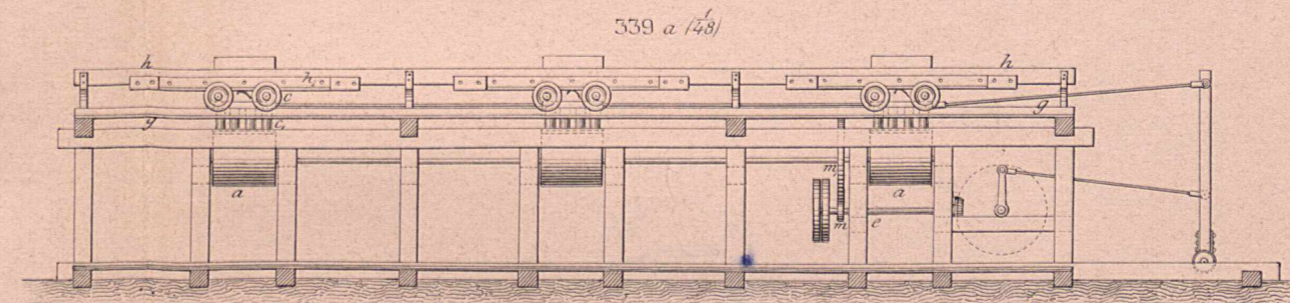
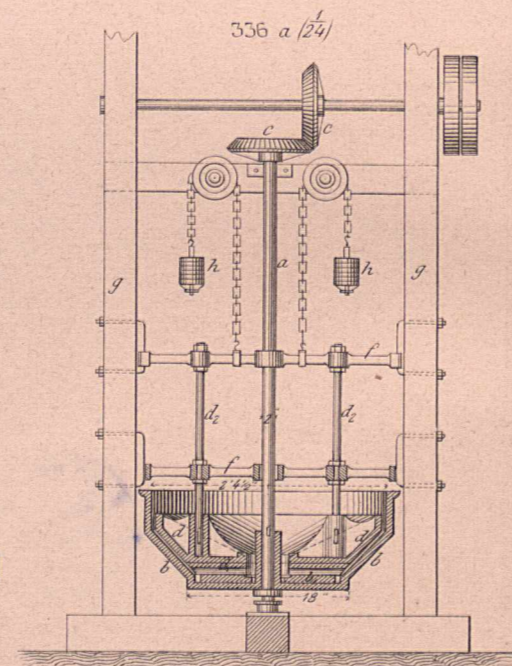
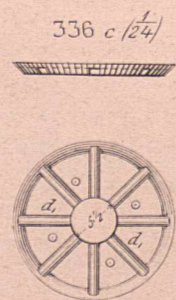
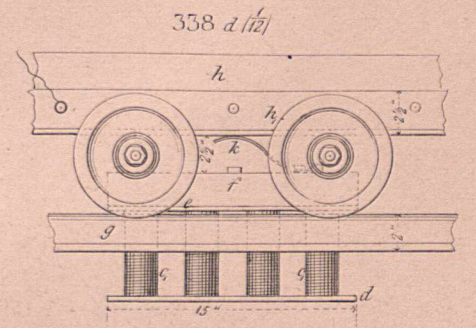
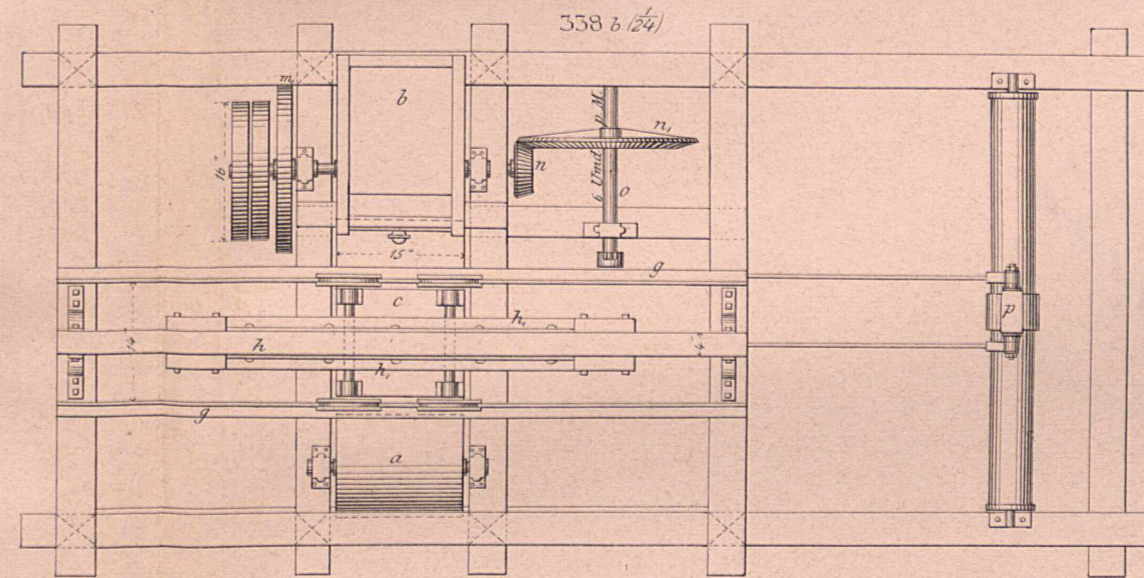
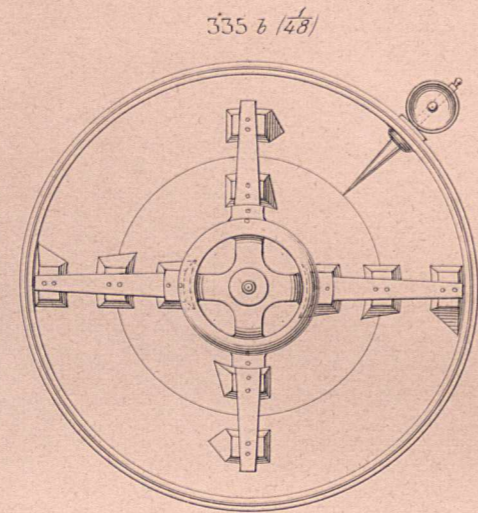
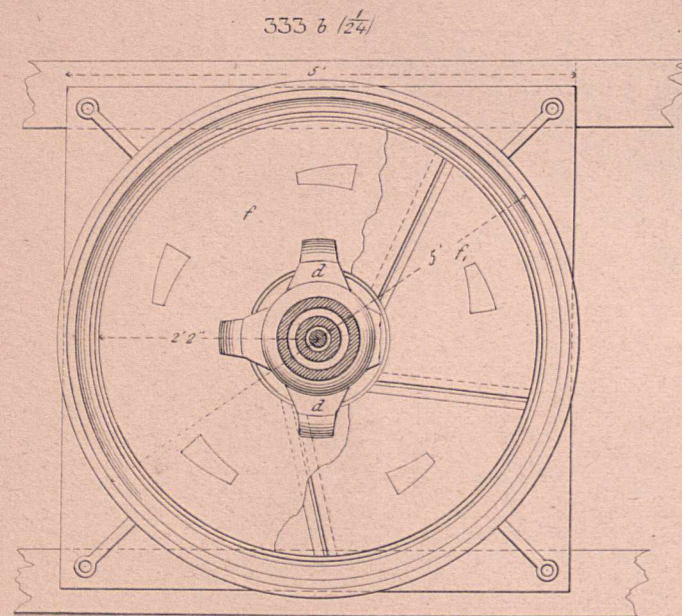
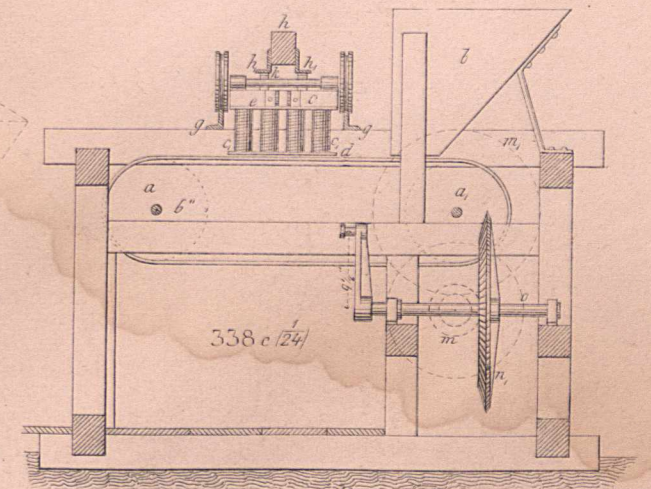
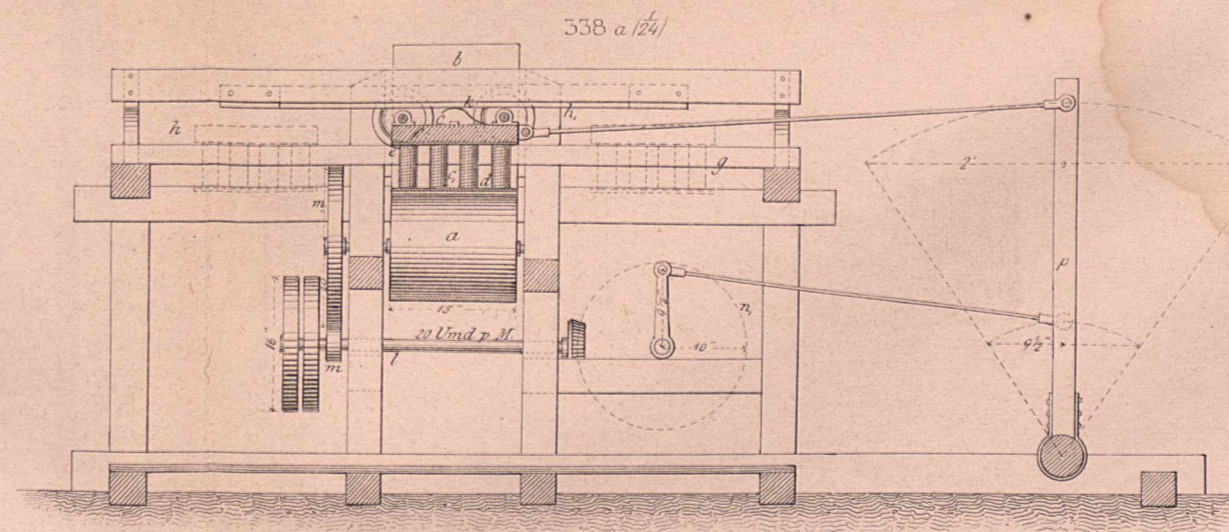
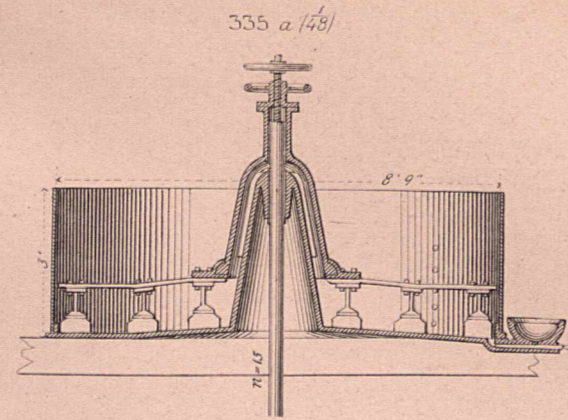
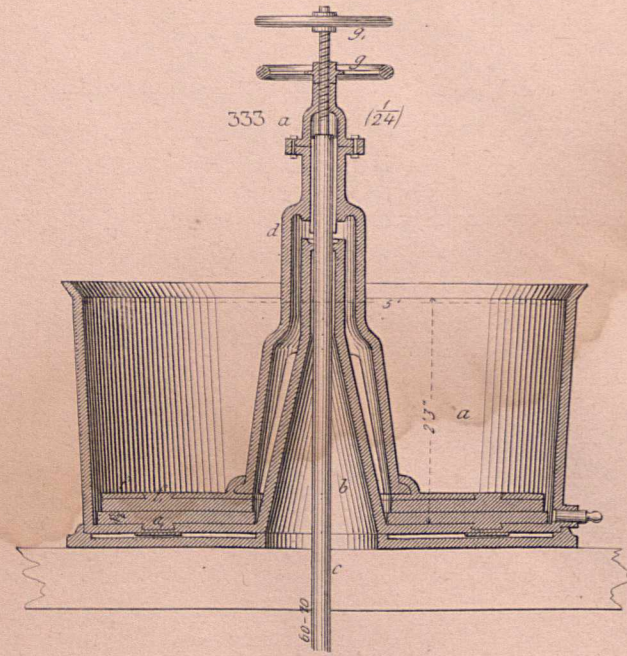



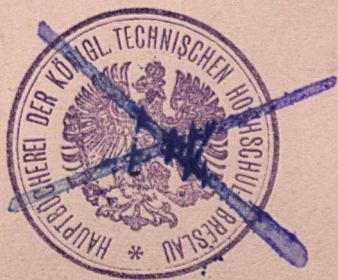

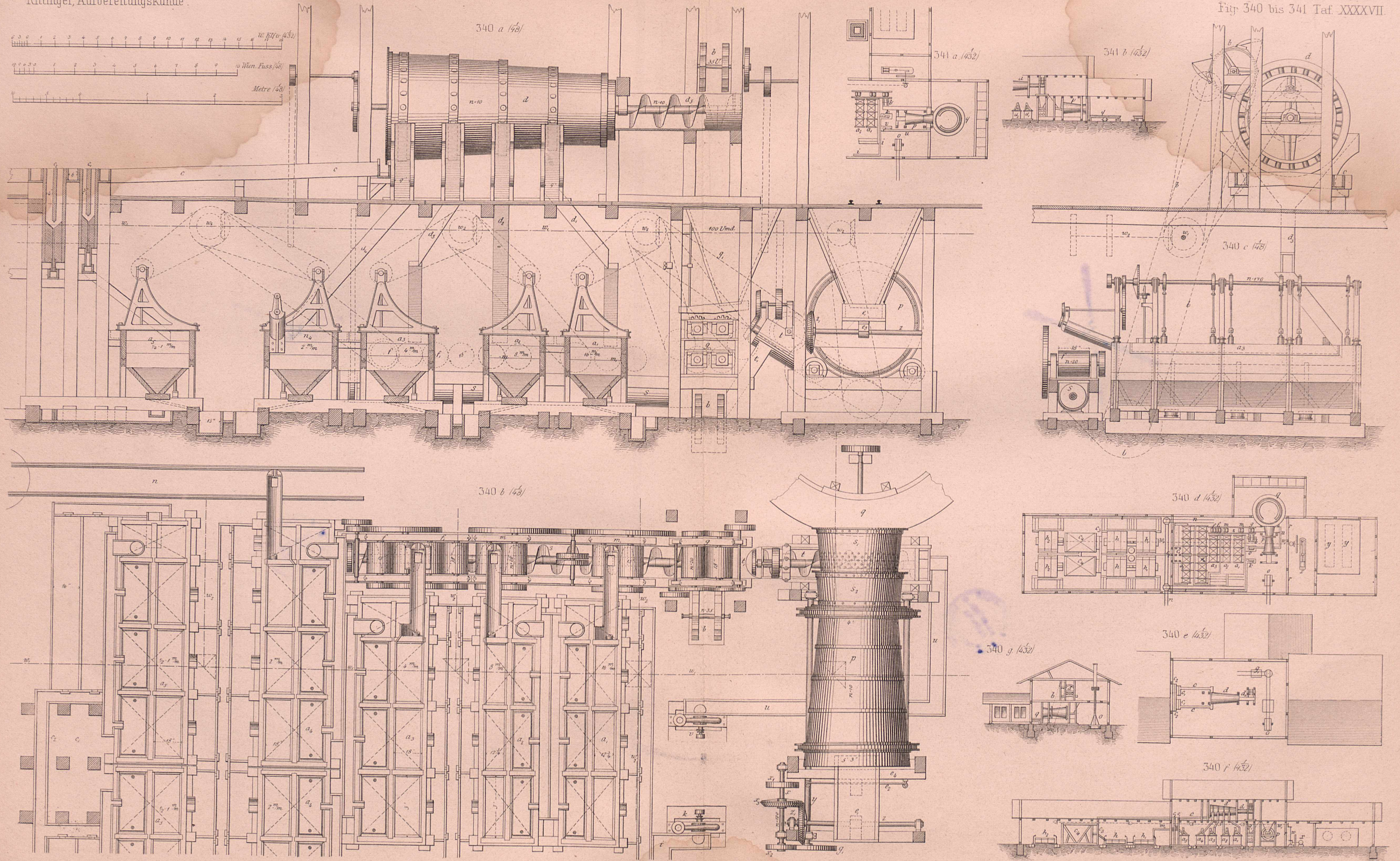





0 1 2 3 4 5 6 7 8 9 10 11 12 13 14 15 16 17 W. Fuss (48)

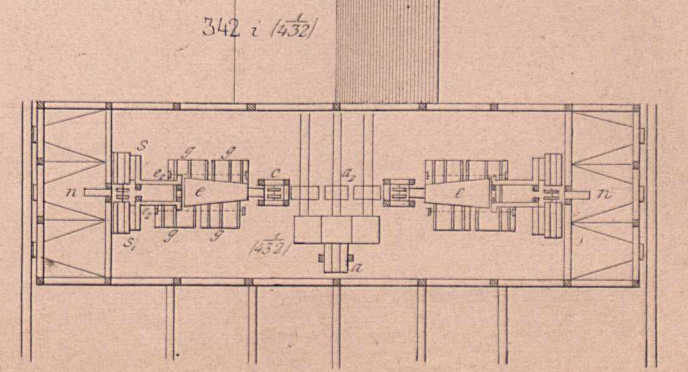
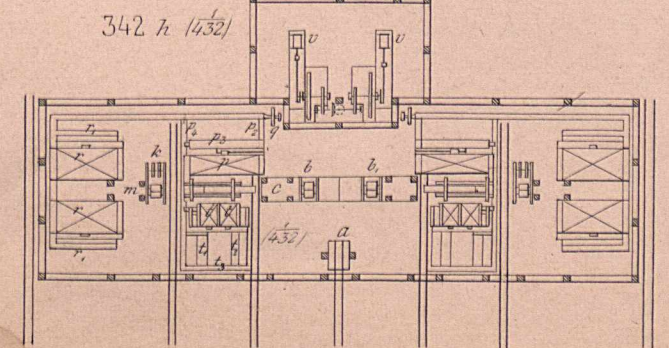
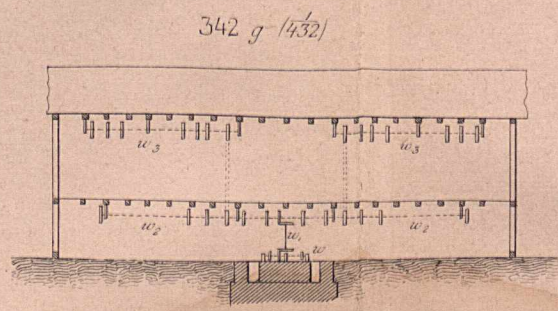
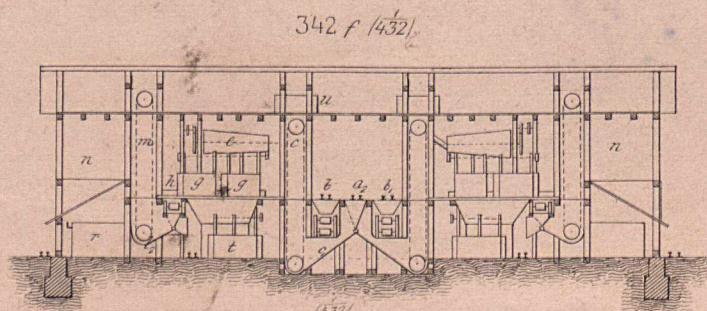
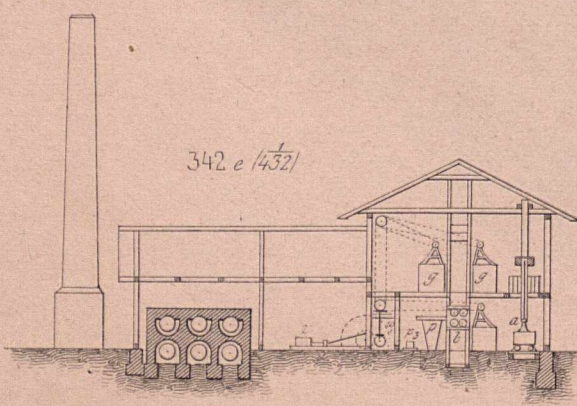
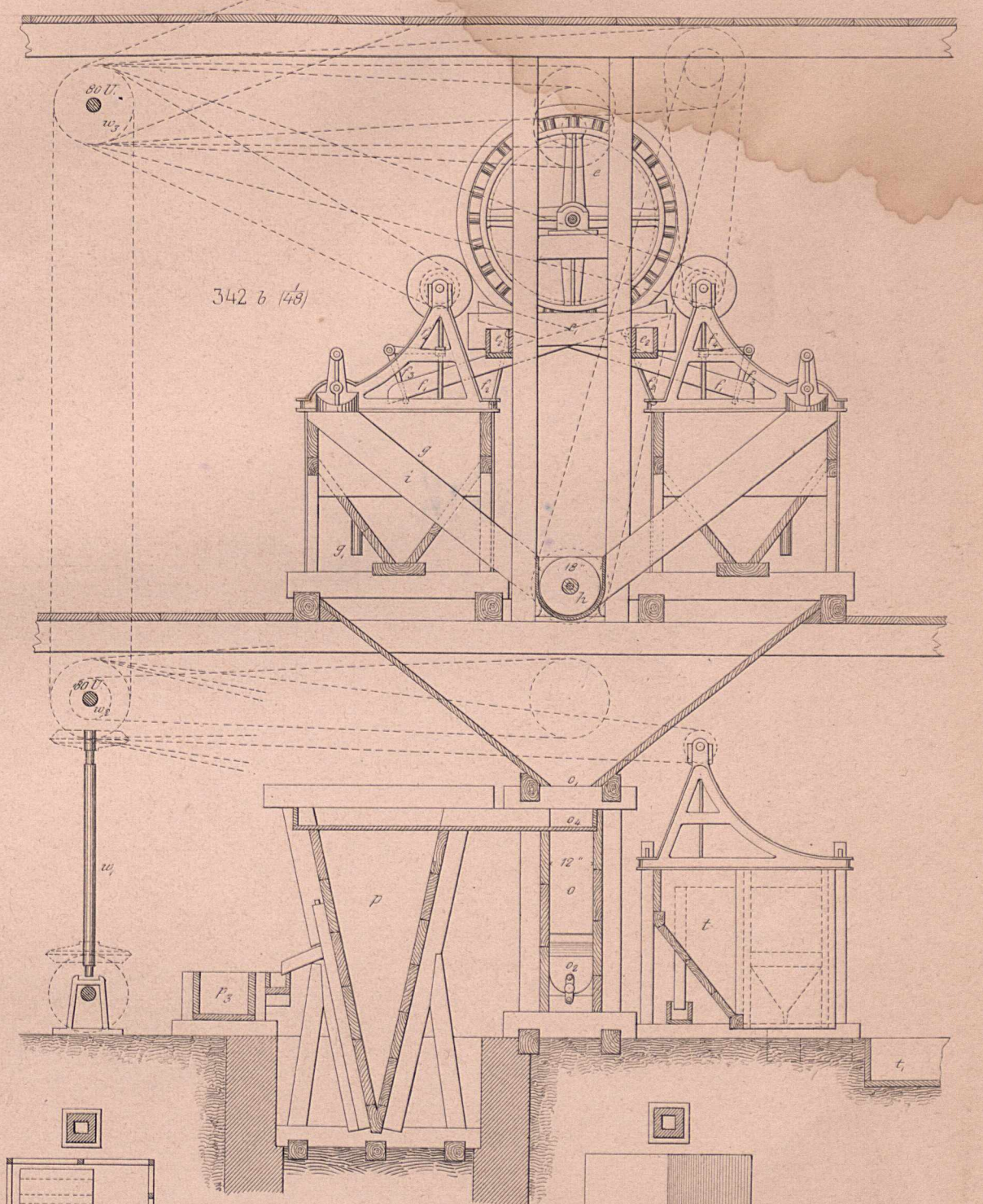
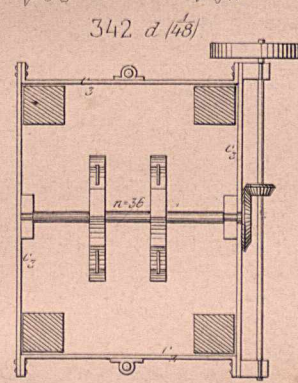
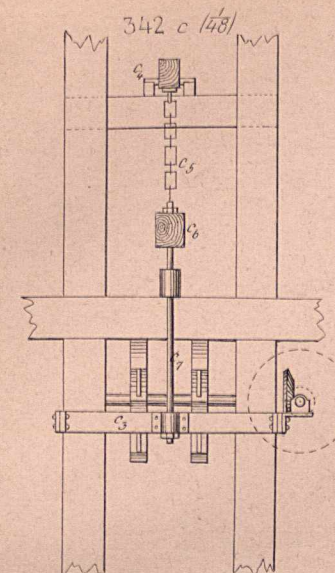
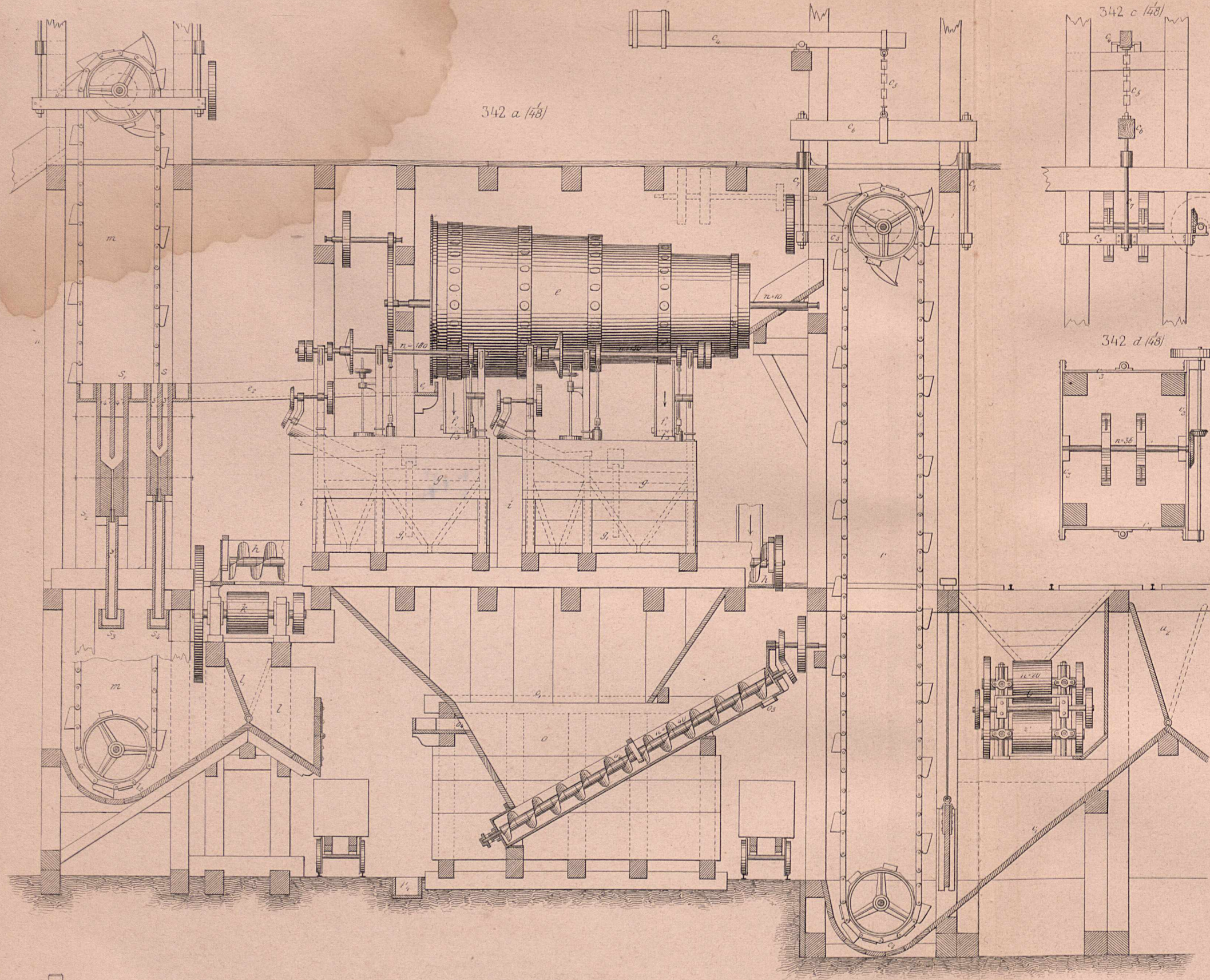

0 1 2 3 4 5 6 7 8 9 10 11 12 13 14 15 16 17 18 19 20 21 22 23 W. Klft. (32)





